

Prepared in cooperation with the San Antonio River Authority

Occurrence and Concentrations of Selected Trace Elements and Halogenated Organic Compounds in Stream Sediments and Potential Sources of Polychlorinated Biphenyls, Leon Creek, San Antonio, Texas, 2012–14



Scientific Investigations Report 2016–5039

Front cover, Looking upstream at U.S. Geological Survey station 08181435 Leon Creek at Loop 410 at San Antonio, Texas, October 2013.

Back cover, U.S. Geological Survey hydrologic technician Michael Scheider collecting a streambed-sediment sample from U.S. Geological Survey station 292240098353600 Leon Creek at Lackland Air Force Base Golf Course, San Antonio, Texas, February 2013.

Occurrence and Concentrations of Selected Trace Elements and Halogenated Organic Compounds in Stream Sediments and Potential Sources of Polychlorinated Biphenyls, Leon Creek, San Antonio, Texas, 2012–14

By Jennifer T. Wilson

Prepared in cooperation with the San Antonio River Authority

Scientific Investigations Report 2016–5039

U.S. Department of the Interior
U.S. Geological Survey

U.S. Department of the Interior
SALLY JEWELL, Secretary

U.S. Geological Survey
Suzette M. Kimball, Director

U.S. Geological Survey, Reston, Virginia: 2016

For more information on the USGS—the Federal source for science about the Earth, its natural and living resources, natural hazards, and the environment—visit <http://www.usgs.gov> or call 1–888–ASK–USGS.

For an overview of USGS information products, including maps, imagery, and publications, visit <http://www.usgs.gov/pubprod/>.

Any use of trade, firm, or product names is for descriptive purposes only and does not imply endorsement by the U.S. Government.

Although this information product, for the most part, is in the public domain, it also may contain copyrighted materials as noted in the text. Permission to reproduce copyrighted items must be secured from the copyright owner.

Suggested citation:

Wilson, J.T., 2016, Occurrence and concentrations of selected trace elements and halogenated organic compounds in stream sediments and potential sources of polychlorinated biphenyls, Leon Creek, San Antonio, Texas, 2012–14: U.S. Geological Survey Scientific Investigations Report 2016–5039, 99 p., <http://dx.doi.org/10.3133/sir20165039>.

ISSN 2328-031X (print)
ISSN 2328-0328 (online)

Acknowledgments

The author wishes to acknowledge personnel at Joint Base San Antonio-Lackland for their assistance with base access to sample Leon Creek within the base boundaries. She also wishes to acknowledge the Texas Department of Transportation for their assistance with the installation of a passive sampler at the bridge over Leon Creek and Interstate Highway 410.

Contents

Acknowledgments	iii
Abstract	1
Introduction	2
Purpose and Scope	2
Description of the Study Area and Sampling Sites	6
Previous Studies	7
Methods	7
Sample Collection	8
Streambed-Sediment Samples	8
Suspended-Sediment Samples	9
Analytical Methods	9
Quality Control	11
Concentrations and Occurrence of Selected Trace Elements and Halogenated Organic Compounds	17
Trace Elements	17
Halogenated Organic Compounds	19
Pesticides	19
Flame Retardants	21
Polychlorinated Biphenyls	22
Potential Sources of Polychlorinated Biphenyls	24
Summary	33
References Cited	34

Figures

1. Maps showing locations of the *A*, Leon Creek drainage area and fish consumption advisory stream segment and *B*, stream-sediment sampling sites, in Bexar County, Texas3
2. Map showing locations of stream-sediment sampling sites on Leon Creek in San Antonio, Texas, 2007–9 and 2012–145
3. Photographs showing streambed-sediment sample collection methods used at Leon Creek in San Antonio, Texas, 2012–14. *A*, Hydrologic technician collecting surficial streambed sediment from a depositional zone; and *B*, Hydrologic technician processing a surficial streambed-sediment sample8
4. Diagram and photographs showing suspended-sediment sample collection methods used at Leon Creek in San Antonio, Texas, 2012–14. *A*, Passive sampler used to collect suspended-sediment samples; *B*, Hydrologic technician removing bottles from passive samplers after a storm; and *C*, Suspended sediment isolated on a Teflon membrane after filtration of a stormwater-runoff sample10
5. Graphs showing the comparison of consensus-based sediment-quality guidelines with concentrations of trace elements in streambed- and suspended-sediment samples collected from Leon Creek, San Antonio, Texas, 2012–1418

6.	Graph showing the percentage of organic carbon in streambed- and suspended-sediment samples collected from Leon Creek, San Antonio, Texas, 2007–9 and 2012–14	19
7.	Graph showing detection frequencies of pesticides in streambed- and suspended-sediment samples, by site (table 1), collected from Leon Creek, San Antonio, Texas, 2012–14	20
8.	Graphs showing the comparison of consensus-based sediment-quality guidelines with concentrations of pesticides in streambed- and suspended-sediment samples collected from Leon Creek, San Antonio, Texas, 2012–14	21
9.	Graph showing detection frequencies of brominated flame retardants in streambed- and suspended-sediment samples, by site (table 1), collected from Leon Creek, San Antonio, Texas, 2012–14	22
10.	Graphs showing the comparison of Environment Canada (2013) Federal Environmental Quality Guidelines with concentrations of brominated flame retardants in streambed- and suspended-sediment samples collected from Leon Creek, San Antonio, Texas, 2012–14	23
11.	Graph showing detection frequencies of polychlorinated biphenyl congeners in streambed- and suspended-sediment samples, by site (table 1), from Leon Creek, San Antonio, Texas, 2012–14	24
12.	Graph showing concentrations of total polychlorinated biphenyls in streambed- and suspended-sediment samples collected from Leon Creek, San Antonio, Texas, 2007–9 and 2012–14	25
13.	Graphs showing examples of polychlorinated biphenyl congener concentrations normalized to the sum of the detected congener concentrations in selected stream-sediment samples collected from Leon Creek, San Antonio, Texas, 2007–9 and 2012–14	26
14.	Graphs showing comparison of polychlorinated biphenyl congeners in commercial Aroclor mixtures and selected streambed- and suspended-sediment samples collected from Leon Creek, San Antonio, Texas, 2007–8 and 2014	32

Tables

1.	Characteristics of the catchment area of each site where streambed- and suspended-sediment samples were collected from Leon Creek, San Antonio, Texas, 2012–14	6
2.	Streambed- and suspended-sediment samples collected from sites on Leon Creek, San Antonio, Texas, 2012–14	8
3.	Relative percent difference (RPD) of concentrations of inorganic and organic constituents in duplicate streambed- and suspended-sediment samples collected from sites on Leon Creek, San Antonio, Texas, 2012–14	40
4.	The mean and median relative percent difference (RPD) between duplicate stream-sediment samples collected from Leon Creek in San Antonio, Texas, 2012–14	11
5.	Comparison of U.S. Geological Survey (USGS) analytical laboratory results to the National Institute of Standards and Technology (NIST) reference materials	13

6.	Concentration of organic constituents in U.S. Geological Survey National Water Quality Laboratory quality-control samples included with sample sets for stream-sediment samples collected from Leon Creek, San Antonio, Texas, 2012–14	53
7.	Surrogate recoveries in streambed- and suspended-sediment samples collected from sites on Leon Creek, San Antonio, Texas, 2012–14	15
8.	Concentrations of inorganic and organic constituents in streambed- and suspended-sediment samples collected from sites on Leon Creek, San Antonio, Texas, 2012–14	65
9.	The consensus-based sediment-quality guidelines of MacDonald and others (2000) that were used to evaluate the contaminant concentrations in streambed- and suspended-sediment samples collected from Leon Creek in San Antonio, Texas, 2012–14	17
10.	Chi-square (X^2) test statistics between proportional polychlorinated biphenyl (PCB) congener profiles of stream-sediment samples collected from sites on Leon Creek, San Antonio, Texas, 2007–9 and 2012–14	28
11.	Summary of mean and standard deviation (mean \pm standard deviation) of Chi-square (X^2) test statistics between proportional polychlorinated biphenyl (PCB) congener profiles of stream-sediment samples collected from sites on Leon Creek, San Antonio, Texas, 2007–9 and 2012–14	31

Conversion Factors

International System of Units to Inch/Pound

Multiply	By	To obtain
Length		
centimeter (cm)	0.3937	inch (in.)
millimeter (mm)	0.03937	inch (in.)
meter (m)	3.281	foot (ft)
kilometer (km)	0.6214	mile (mi)
kilometer (km)	0.5400	mile, nautical (nmi)
meter (m)	1.094	yard (yd)
Area		
square kilometer (km ²)	247.1	acre
square kilometer (km ²)	0.3861	square mile (mi ²)
Volume		
liter (L)	33.82	ounce, fluid (fl. oz)
liter (L)	2.113	pint (pt)
liter (L)	1.057	quart (qt)
liter (L)	0.2642	gallon (gal)
liter (L)	61.02	cubic inch (in ³)
Mass		
gram (g)	0.03527	ounce, avoirdupois (oz)
kilogram (kg)	2.205	pound avoirdupois (lb)

Temperature in degrees Celsius (°C) may be converted to degrees Fahrenheit (°F) as °F = (1.8 × °C) + 32.

Datum

Horizontal coordinate information is referenced to the North American Datum of 1983 (NAD 83).

Selected Abbreviations

AFB	Air Force Base
AFCEC	Air Force Civil Engineer Center
DDD	Dichlorodiphenyldichloroethane
DDE	Dichlorodiphenyldichloroethylene
DDT	Dichlorodiphenyltrichloroethane
FEQG	Federal Environmental Quality Guidelines
IRL	Interim reporting level
NAWQA	National Water-Quality Assessment
NIST	National Institute of Standards and Technology
NWQL	National Water Quality Laboratory
PBDE	Polybrominated diphenyl ether
PCB	Polychlorinated biphenyl
PEC	Probable effect concentration
RPD	Relative percent difference
SQG	Sediment-quality guideline
TCEQ	Texas Commission on Environmental Quality
TEC	Threshold effect concentration
USGS	U.S. Geological Survey

Occurrence and Concentrations of Selected Trace Elements and Halogenated Organic Compounds in Stream Sediments and Potential Sources of Polychlorinated Biphenyls, Leon Creek, San Antonio, Texas, 2012–14

By Jennifer T. Wilson

Abstract

The Texas Department of State Health Services issued fish consumption advisories in 2003 and 2010 for Leon Creek in San Antonio, Texas, based on elevated concentrations of polychlorinated biphenyls (PCBs) in fish tissues. The U.S. Geological Survey (USGS) measured elevated PCB concentrations in stream-sediment samples collected during 2007–9 from Leon Creek at Lackland Air Force Base (now known as Joint Base San Antonio-Lackland; the sampling site at this base is hereinafter referred to as the “Joint Base site”) and sites on Leon Creek downstream from the base. This report describes the occurrence and concentrations of selected trace elements and halogenated organic compounds (pesticides, flame retardants, and PCBs) and potential sources of PCBs in stream-sediment samples collected from four sites on Leon Creek during 2012–14. In downstream order, sediment samples were collected from Leon Creek at northwest Interstate Highway 410 (Loop 410), Rodriguez Park, Morey Road, and Joint Base. The USGS periodically collected streambed-sediment samples during low flow and suspended-sediment samples during high flow.

Trace element concentrations were low compared to the consensus-based sediment-quality guidelines (SQGs) for the threshold effect concentration (TEC) and probable effect concentration (PEC). Adverse effects to benthic biota are not expected at concentrations less than the TEC and are expected at concentrations greater than the PEC. No trace element concentrations were greater than the PEC in any of the samples. Trace element concentrations were greatest at the Morey Road and Joint Base sites and exceeded the TECs by 41 and 27 percent, respectively. Trace element concentrations were lowest at the Rodriguez Park and Loop 410 sites and exceeded the TECs by 18 and 14 percent, respectively.

Pesticides that have been banned for several decades are commonly detected in Leon Creek stream sediments, particularly the chlordane compounds. Chlordane compounds were detected in 84 percent of the samples and at every sample collection site. The samples collected from the Rodriguez Park site had the most pesticide

compounds detected. Only samples collected from the Joint Base site had dichlorodiphenyldichloroethane (DDD), dichlorodiphenyldichloroethylene (DDE), or dichlorodiphenyltrichloroethane (DDT) concentrations greater than the TEC, and a few were also greater than the PEC.

Flame retardants were found at every site on Leon Creek where stream sediments were collected; however, a few compounds were frequently detected in the laboratory reagent blanks so their detections in the environmental samples may not be from local sources. Consensus-based SQGs were not available for flame retardants so samples were compared to Environment Canada Federal Environmental Quality Guidelines (FEQGs). The concentrations of flame retardants generally were greater in the suspended-sediment samples than the streambed-sediment samples and greater than the FEQGs in many cases.

Eighteen PCB congeners were quantified in the sediment samples collected from Leon Creek. The samples collected from the Joint Base site had the most frequent PCB congener detections. Total PCB concentrations, computed as the sum of the 18 congeners by using the Kaplan-Meier method for left-censored environmental data, were much smaller than the TEC of 59.8 micrograms per kilogram ($\mu\text{g}/\text{kg}$). When detected, the concentrations of total PCBs in the stream-sediment samples collected from Leon Creek during 2012–14 ranged from an estimated 0.2 to 8.7 $\mu\text{g}/\text{kg}$.

Sediment samples collected from Leon Creek by the USGS during 2007–9 and 2012–14 at a total of eight sites following identical field and laboratory methods were evaluated to determine if potential PCB sources could be identified. Total PCB concentrations in the sediment samples collected upstream from the Joint Base site were low or nondetections; while concentrations in the samples collected on and downstream from the Joint Base site were greater. Congeners 180 and 138 constituted the greatest proportion of the PCB mixture in samples collected upstream from, on, and downstream from the Joint Base site. Upstream from the Joint Base site, congeners 180 and 138 constituted 50 percent and 35 percent respectively of the PCBs congeners found in the samples. On and downstream from the Joint Base site,

2 Occurrence and Concentrations of Selected Trace Elements and Halogenated Organic Compounds in Stream Sediments

congeners 180 and 138 constituted 80 percent and 13 percent respectively of the PCBs congeners found in the samples. Chi-square (X^2) tests also indicate that samples collected from the Loop 410 site were statistically different from samples collected from the Joint Base site and sites downstream. The PCB congener pattern in the Leon Creek samples is most like the congener mixture in Aroclor 1260, which is chemically similar to the PCBs detected in the fish samples that resulted in the 2003 fish consumption advisory.

Introduction

Elevated concentrations of several trace elements and selected halogenated organic compounds (pesticides, flame retardants, and polychlorinated biphenyls [PCBs]) have been documented in streambed- and suspended-sediment samples collected from sites on Leon Creek in Bexar County, Texas, and in the San Antonio River, which receives inflows from Leon Creek (Wilson, 2011). Trace elements and halogenated organic compounds strongly associate with streambed and suspended sediments; the concentrations in the top few centimeters of bottom sediment and in suspended sediment are typically orders of magnitude greater than the concentration in the water column (Horowitz, 1991; Rostad and others, 1995). Halogenated organic compounds include one or more halogen elements (chlorine, bromine, fluorine, and iodine) in their chemical structure, which makes them resistant to environmental degradation. Because these compounds break down slowly, they commonly persist in the environment for many years or decades; they are also resistant to metabolism and accumulate in food chains (Jones and de Voegt, 1999). Several of the flame retardants and PCBs were reported as congeners, which are compounds with similar base structures but unique numbers and positions of halogen substituents. Many of the elevated concentrations of trace elements and halogenated organic compounds were measured in sediment samples collected from Leon Creek at or downstream from the Lackland Air Force Base (now known as Joint Base San Antonio-Lackland). The Texas Department of State Health Services issued fish consumption advisories in 2003 and 2010 for Leon Creek from the Old U.S. Highway 90

bridge downstream to Southwest Military Drive (2003) and southwest Loop 410 (2010) for PCBs (figs. 1A and 1B) (Texas Department of Health, 2003; Texas Department of State Health Services, 2010). The U.S. Geological Survey (USGS), in cooperation with the San Antonio River Authority, collected additional streambed- and suspended-sediment samples (collectively referred to as stream-sediment samples) during 2012–14 to characterize trace elements and selected halogenated organic compounds in the upper reaches of Leon Creek, from northwest Interstate Highway 410 downstream to Joint Base San Antonio-Lackland. The analysis of stream-sediment samples collected from sites upstream from Joint Base San Antonio-Lackland (fig. 2) also provides information about possible contaminant sources within the drainage area upstream from the base.

Purpose and Scope

This report describes the concentrations of selected trace elements, pesticides, flame retardants, and PCBs in stream-sediment samples that were collected during 2012–14 from four sites on Leon Creek, in Bexar County, Tex., compares these results with the results of samples collected during 2007–9 from a previous study of the same contaminants in stream-sediment samples (Wilson, 2011), and describes possible sources of PCBs. Streambed-sediment and suspended-sediment samples were collected during 2012–14 from Leon Creek in Bexar County, Tex., on and upstream from Joint Base San Antonio-Lackland. The degree of contamination of each sample was assessed by comparing concentrations to consensus-based sediment-quality guidelines (SQGs). The frequencies at which the organic contaminants were detected in the samples were assessed. Comparisons of concentrations among sites were made to describe the occurrence and distribution of the contaminants. Eighteen PCB congeners were quantified in the sediment samples and used to evaluate potential sources of the PCBs. The Kaplan-Meier nonparametric statistic and Chi-square (X^2) test statistic were used for data analysis and interpretation. Because of the small size of the dataset, temporal trends in contaminant concentrations were not assessed. Major-element analyses are included in the report for completeness but are not discussed.

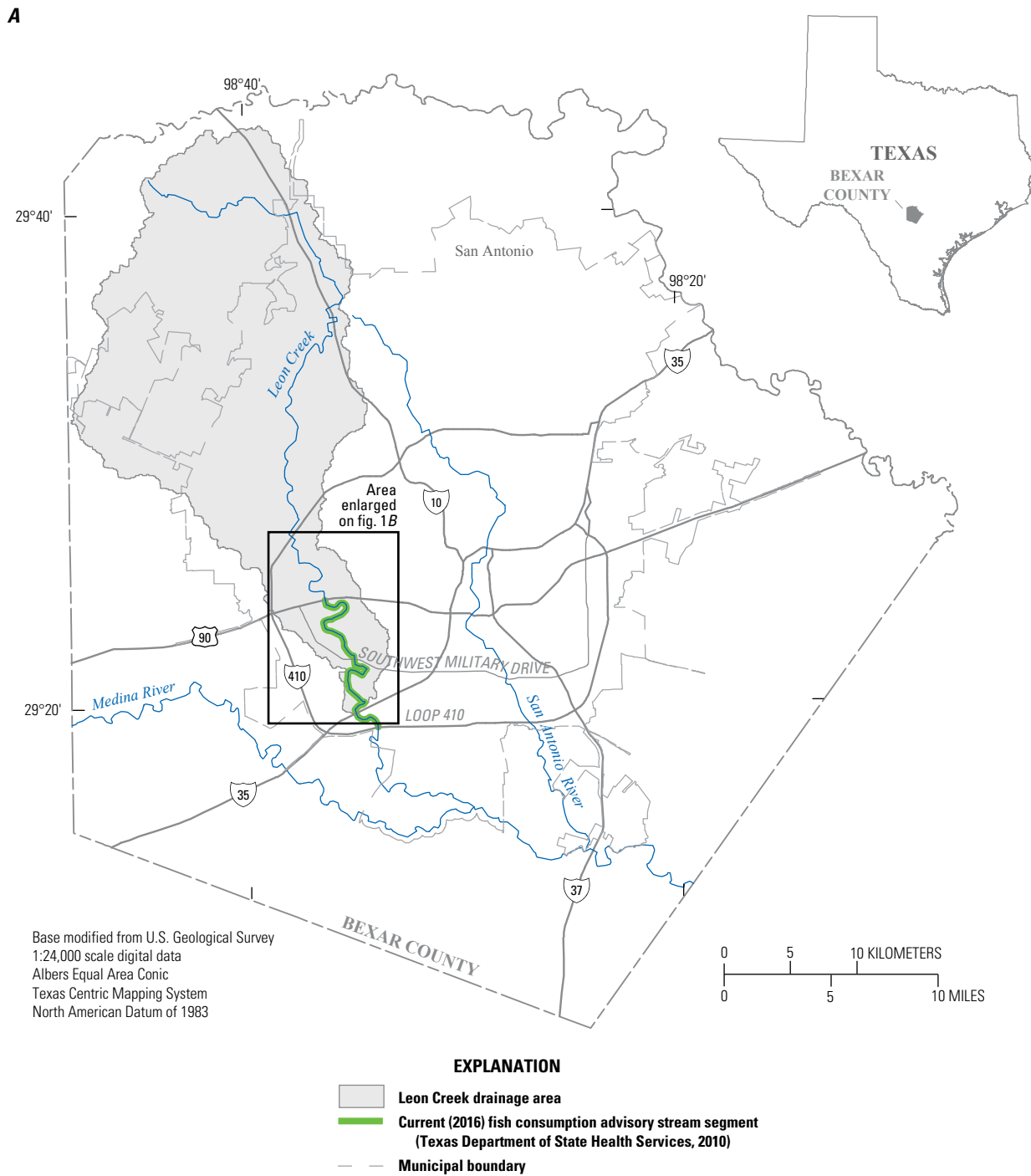

Figure 1. Locations of the *A*, Leon Creek drainage area and fish consumption advisory stream segment and *B*, stream-sediment sampling sites, in Bexar County, Texas.

4 Occurrence and Concentrations of Selected Trace Elements and Halogenated Organic Compounds in Stream Sediments

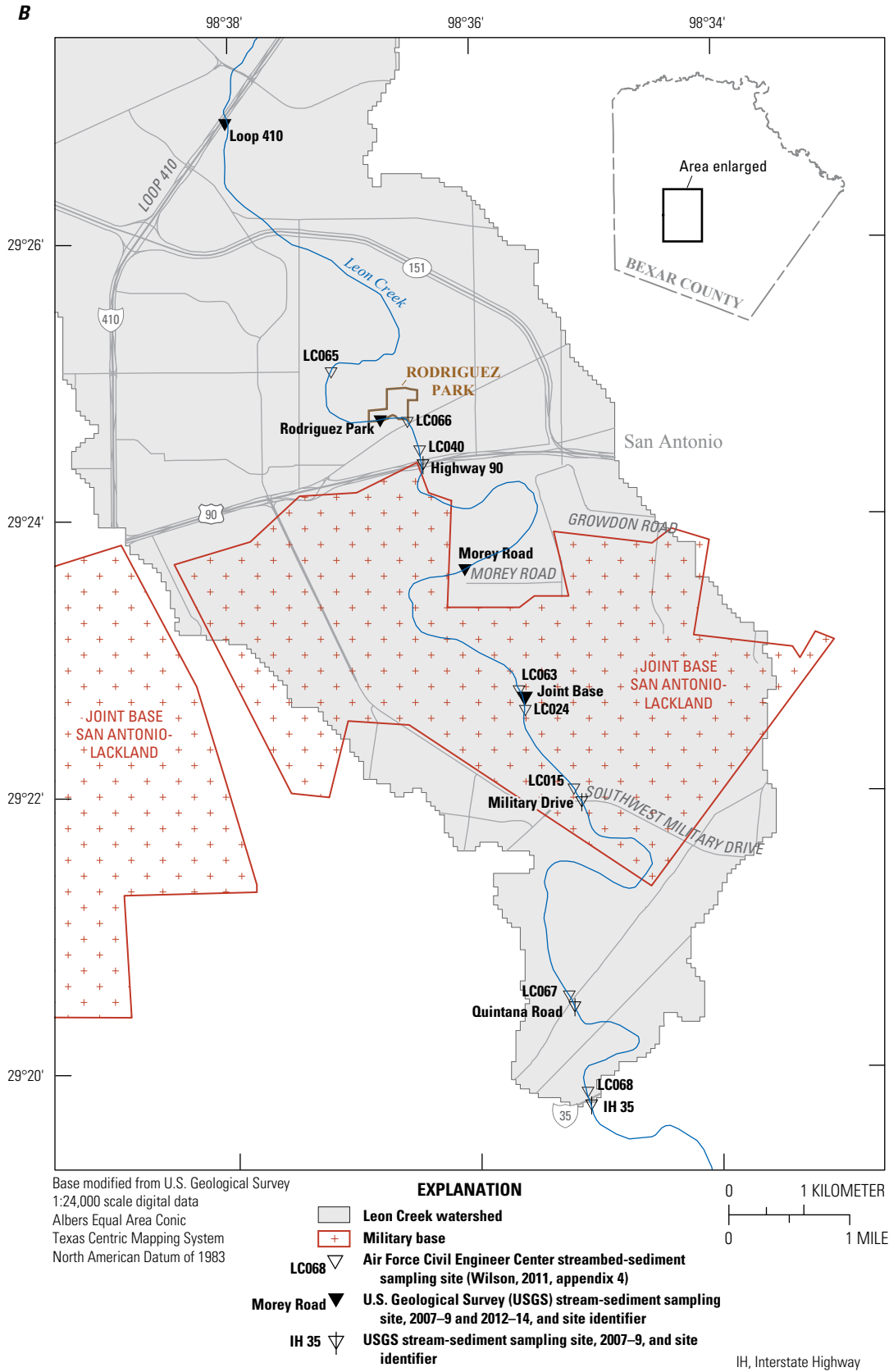

Figure 1. Maps showing locations of the A, Leon Creek drainage area and fish consumption advisory stream segment and B, stream-sediment sampling sites, in Bexar County, Texas.—Continued

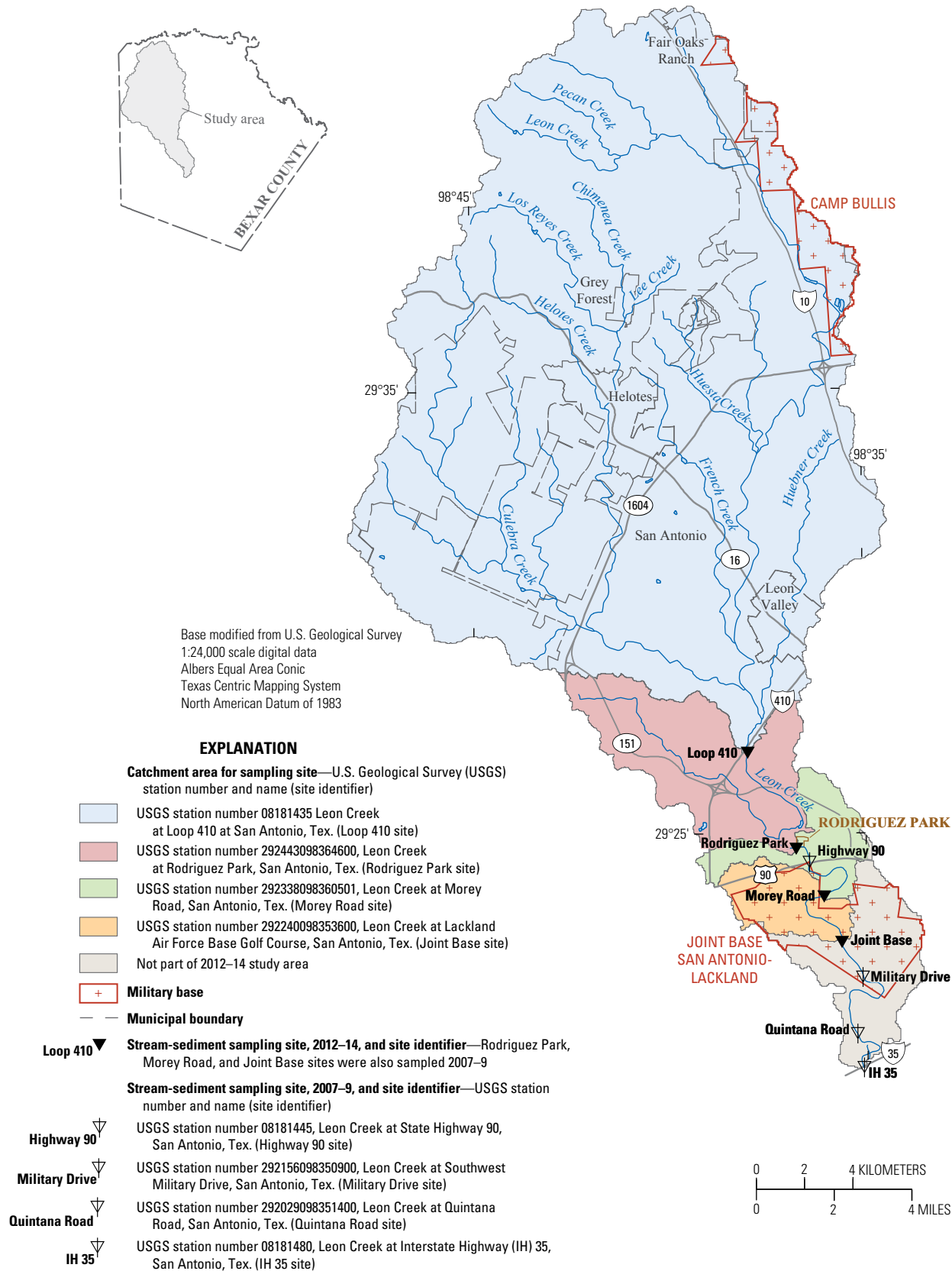

Figure 2. Locations of stream-sediment sampling sites on Leon Creek in San Antonio, Texas, 2007–9 and 2012–14.

Description of the Study Area and Sampling Sites

The study area consists of the drainage area of Leon Creek upstream from Interstate Highway 35 (figs. 1 and 2) in Bexar County, Tex. Most of Bexar County is coincident with the greater San Antonio, Tex., urban area; in 2014, San Antonio was the second largest city in Texas and the seventh largest city in the United States (U.S. Census Bureau, 2015). The sites where stream-sediment samples were collected during 2012–14 are located along Leon Creek at northwest Loop 410, in Rodriguez Park, at Morey Road, and on the southern part of Joint Base San Antonio-Lackland. The USGS station names and the short names used as the site identifiers for these four sampling sites are USGS station 08181435 Leon Creek at Loop 410 at San Antonio, Tex. (hereinafter referred to as the “Loop 410 site”); USGS station 292443098364600 Leon Creek at Rodriguez Park, San Antonio, Tex. (hereinafter referred to as the “Rodriguez Park site”); USGS station 292338098360501 Leon Creek at Morey Road, San Antonio, Tex. (hereinafter referred to as “Morey Road site”); and USGS station 292240098353600 Leon Creek at Lackland Air Force Base Golf Course, San Antonio, Tex. (hereinafter referred to as “the Joint Base site”). The sites where stream-sediment samples were collected during 2007–9 include Rodriguez Park, Morey Road, and Joint Base in addition to USGS station 08181445 Leon Creek at State Highway 90, San Antonio, Tex. (hereinafter referred to as the “Highway 90 site”);

USGS station 292156098350900 Leon Creek at Southwest Military Drive, San Antonio, Tex. (hereinafter referred to as the “Military Drive site”); USGS station 292029098351400 Leon Creek at Quintana Road, San Antonio, Tex. (hereinafter referred to as the “Quintana Road site”); and USGS station 08181480 Leon Creek at Interstate Highway 35, San Antonio, Tex. (hereinafter referred to as the “IH 35 site”). The 2007–9 sediment results were included in the assessment of potential sources of PCBs.

The catchment areas (fig. 2), which for the purposes of this report are defined (with one exception) as the drainage area between two sites, and land cover in the catchment area of each site sampled during 2012–14 are summarized (table 1). Unlike the catchment areas for the other sites, the catchment area for the Loop 410 site is not bounded by two sites; rather, it is the entire Leon Creek watershed upstream from where the Loop 410 site is located. Of all the sites, the Loop 410 site has the largest catchment area with the lowest percentage of developed land cover. The Joint Base site has the smallest catchment area with the highest percentage of developed land cover. Kelly Air Force Base (AFB) operated during 1971–2001 and was located mostly in the catchment area of the Joint Base site (figs. 1B and 2). After Kelly AFB was closed, parts of the installation were shifted to Lackland AFB, and an industrial complex currently (2016) known as Port San Antonio. Lackland AFB joined Fort Sam Houston, Camp Bullis, and Randolph AFB to form Joint Base San Antonio-Lackland in 2010 (Joint Base San Antonio, 2015).

Table 1. Characteristics of the catchment area of each site where streambed- and suspended-sediment samples were collected from Leon Creek, San Antonio, Texas, 2012–14. Land cover data are from the National Land Cover Database 2011 (Homer and others, 2015).

[km², square kilometers]

U.S. Geological Survey station number and name (fig. 2)	Site identifier	Catchment area (km ²)	Land cover (percent)							
			Developed	Forest	Shrubland	Planted/cultivated	Herbaceous	Wetlands	Barren	Water
08181435 Leon Creek at Loop 410 at San Antonio, Tex.	Loop 410	445.3	41.9	39.9	10.2	0.7	6.5	0.3	0.4	0.1
292443098364600 Leon Creek at Rodriguez Park, San Antonio, Tex.	Rodriguez Park	40.6	76.7	9.2	5.5	2.9	1.9	3.2	0.4	0.2
292338098360501 Leon Creek at Morey Road, San Antonio, Tex.	Morey Road	14.4	63.7	2.4	7.9	13.3	2.7	10.0	0.0	0.0
292240098353600 Leon Creek at Lackland Air Force Base Golf Course, San Antonio, Tex.	Joint Base	12.4	87.4	1.5	4.6	1.5	2.8	1.8	0.4	0.0

As expected in most urban areas, there are numerous potential sources of contamination in the Leon Creek drainage area. The Texas Commission on Environmental Quality (TCEQ) Source Water Assessment Program identified abandoned municipal landfills and industrial wastewater outfalls as the two most common potential sources of contamination in the Leon Creek drainage area (Texas Commission on Environmental Quality, 2009; Wilson, 2011, fig. 3). The TCEQ listed PCBs as possible contaminants associated with both types of potential sources; furthermore, the Alamo Area Council of Governments (2005) compiled information such as approximate location, size, and years of operation of several closed landfills near the stream-sediment sampling sites. Although several potential sources of PCBs to Leon Creek were identified, none of the potential sources were sampled as part of this study.

Previous Studies

Federal and State agencies have measured concentrations of trace elements, pesticides, and PCBs along with other contaminants in biological and stream-sediment samples collected from Leon Creek. This section provides a brief overview of those sampling efforts.

Previous USGS studies of Leon Creek in San Antonio included the collection of biological and streambed-sediment samples from the IH 35 site for trace elements, pesticides, and PCBs between 1995 and 2001 as part of the National Water-Quality Assessment (NAWQA) program (Wilson, 2011, apps. 3.1 and 3.2). The USGS measured streambed- and suspended-sediment contaminants at seven sites in Leon Creek during 2007–9 in a study of stream-sediment quality in Bexar County (Wilson, 2011). That study determined the greatest overall degree of sediment contamination relative to other streams in Bexar County was found in Leon Creek; the primary contaminants of concern were cadmium, chromium, chlordane, dichlorodiphenyldichloroethylene (DDE), and PCBs.

An Installation Restoration Program (U.S. Environmental Protection Agency, 2000, p. 4) was initiated at the former Kelly AFB in 1982 to assess and remediate contaminated sites on the base. The Air Force Civil Engineer Center (AFCEC), previously known as the Air Force Center for Environmental Excellence, oversees semiannual compliance sampling of Leon Creek sediment near the former Kelly AFB. Numerous sites on Leon Creek are sampled twice a year and analyzed for trace elements, pesticides, and PCBs. The results for samples collected during 1994–2008 are summarized in a previous USGS report (Wilson, 2011, table 6 and app. 4). Most of the USGS results for samples collected during 2007–9 and 2012–14 are within the ranges of concentrations measured by AFCEC with a few exceptions where USGS concentrations are greater (zinc and one of the pesticides, dichlorodiphenyldichloroethane [DDD]); however, differences

between the analytical methods used by the AFCEC and USGS laboratories hindered an indepth statistical analysis of the two datasets.

The Texas Department of State Health Services Seafood and Aquatic Life Group tests tissue samples to inform recreational fishermen of possible disease or contaminants in fish or other aquatic species. The agency tested fish collected in 2002 from several sites in Leon Creek for trace elements, pesticides, and PCBs. Their findings resulted in a fish consumption advisory for PCBs in 2003 for Leon Creek from Highway 90 downstream to Southwest Military Drive (fig. 1B) (Texas Department of Health, 2003). A second fish consumption advisory for PCBs was issued in 2010 for Leon Creek from Highway 90 downstream to southwest Loop 410 (figs. 1 and 2; Texas Department of State Health Services, 2010).

Methods

Three of the four sampling sites on Leon Creek where stream-sediment samples were collected during 2012–14 were at the same locations where the USGS collected sediment samples during 2007–9. The fourth sampling site, Loop 410, is coincident with an existing USGS streamflow-gaging station approximately 6 kilometers (km) upstream from Rodriguez Park (fig. 2). The streambed-sediment sampling sites were along stream reaches in depositional zones that could be sampled by wading the stream. Leon Creek is an ephemeral stream that only flows after storm events at and upstream from the Loop 410 site; it transitions to a perennial stream immediately upstream from the Rodriguez Park site. Where the stream is ephemeral, disconnected pools of water are present except during extreme droughts. The sampling sites were located where the streambed was continually submerged because comparability of wet to dry sediment chemistry is unreliable, especially for organic compounds (Shelton and Capel, 1994). In addition to collecting streambed-sediment samples, suspended-sediment samples were collected from the Loop 410, Rodriguez Park, and Morey Road sites (fig. 2). The suspended-sediment samples were collected to assess concentrations of sediment contaminants during storm events. The sediments in these samples included those introduced to the stream from recent runoff and streambed sediments that were resuspended during storm events and transported further downstream (Colby, 1963; Mahler and others, 2006). As explained by Colby (1963, p. A2) “sediment particles continually change their positions in the flow; some fall to the streambed, and others are removed from the bed. Sediment deposits form locally or over large areas if the volume rate at which particles settle to the bed exceeds the volume rate at which particles are removed from the bed.”

Sample Collection

Sampling began in November 2012 and was completed in July 2014. Streambed-sediment samples were collected from the beginning of the study and after each subsequent suspended-sediment sample (table 2).

Streambed-Sediment Samples

The collection of streambed-sediment samples was based on the methods of the USGS NAWQA program (Shelton and Capel, 1994). The NAWQA streambed-sediment collection guidelines recommend collecting fine-grained particulates from 5 to 10 depositional zones during low-flow conditions, where each zone is approximately 100 meters (m) long, and the distance between depositional zones is reasonable for the scale of the river system. Depositional zones are locations in streams where the energy regime is low, and fine-grained

particles accumulate in the streambed (Shelton and Capel, 1994). Because many depositional zones potentially suitable for sampling were too deeply inundated to wade or inaccessible because of thick vegetation or steep banks, only 3 to 5 depositional zones totaling 230 to 500 m were sampled at each site during 2012–14 (table 2). All streambed-sediment samples were collected by wading the stream; each depositional zone was approached by one or two field personnel from the downstream direction so as not to disturb the streambed sediment (fig. 3A). After rinsing precleaned sampling equipment with native water, surficial streambed sediment (about 1 centimeter) was collected from multiple depositional zones with a Teflon spoon and composited in a glass container. The total volume (wet) of streambed sediment collected from each stream reach was about 1 liter (L). Streambed-sediment samples were stored on ice immediately after collection and processed in the USGS office in San Antonio.

Table 2. Streambed- and suspended-sediment samples collected from sites on Leon Creek, San Antonio, Texas, 2012–14.

Site identifier (table 1)	Total length of reach (meters)	Number of depositional zones	Type and number of samples collected per year					
			2012		2013		2014	
			Streambed sediment	Suspended sediment	Streambed sediment	Suspended sediment	Streambed sediment	Suspended sediment
Loop 410	360	4	1	0	3	3	1	1
Rodriguez Park	230	5	1	0	3	2	1	1
Morey Road	230	5	1	0	3	3	1	1
Joint Base	500	3	1	0	3	0	1	0

A



B



Figure 3. Streambed-sediment sample collection methods used at Leon Creek in San Antonio, Texas, 2012–14. *A*, Hydrologic technician collecting surficial streambed sediment from a depositional zone; and *B*, Hydrologic technician processing a surficial streambed-sediment sample.

Streambed-sediment sample processing involved mixing and sieving the wet sediment (fig. 3B). Sieving the samples eliminated the grain-size variability that has been shown to affect trace-element and organic-compound concentrations in sediment samples (Horowitz and Elrick, 1987; Smith and others, 1988), allowing for more informative comparisons among samples. About half of the sample was sieved by using a 63-micrometer (μm) nylon-cloth sieve for analysis of major and trace elements. Sediment greater than 63 μm (the diameter differentiating larger, sand-size particles from smaller, clay- and silt-size particles) was discarded. The fine material (less than 63 μm) was transferred into 125-milliliter (mL) polypropylene jars and transported on ice to the USGS office in Austin, Tex., where they were freeze-dried, pulverized, and shipped to the USGS Mineral Resources Program Analytical Laboratories in Lakewood, Colorado, for analysis. The other half of the sample was sieved by using a 2.0-millimeter (mm) stainless-steel-mesh sieve on the opening of a 500-mL precleaned glass jar and analyzed for organic compounds. Coarse sediment (greater than 2.0 mm) was discarded. The samples for organic compound analyses were stored at 4 degrees Celsius ($^{\circ}\text{C}$) and shipped on ice to the USGS National Water Quality Laboratory (NWQL) in Lakewood, Colo., for analysis.

Suspended-Sediment Samples

Suspended-sediment samples were collected during high-flow conditions resulting from storm events following the methods described in Mahler and Van Metre (2003) and Van Metre and others (2003). Stormwater runoff was collected in large-volume passive samplers and then filtered to isolate the suspended sediments in the stormwater. Two passive samplers were installed to collect suspended-sediment samples at each sampling site. The passive samplers consisted of a 25-L polyethylene bottle inside a cylindrical steel housing installed in or near the stream channel (figs. 4A and 4B). Each sampler had two water intake nozzles pointed upstream and an air vent line designed to collect “first flush” grab samples at the sampling sites when the stream level rose above the level of the intake nozzles. The intake nozzles were 0.6 m above the bottom of the cylinders. The air vent line allowed air in the bottle to leave as water flowed in and blocked outflow when the bottle was full so that water did not continue to cycle through the bottle. The bottle was removed from the passive sampler after the storm passed and the streamflow receded and transported on ice to the laboratory at the USGS office in Austin for processing.

The processing of the stormwater runoff samples involved filtering the water to isolate the suspended sediments (fig. 4C). The sample was transferred from the 25-L sample bottle into a custom 50-L churn so the sample could be stirred constantly during subsampling and filtration. The samples were filtered through a 0.45- μm Teflon membrane to separate the sediment from the water. To enable water to readily pass through the filters, the Teflon membranes were sprayed with methanol before placing them on the filter holders. About two-thirds of the sample were filtered for organic compound analyses by using a stainless-steel filter holder. The remaining third of the sample was filtered for analysis of major and trace elements by using an acrylic filter holder. After filtration, the sediment was gently scraped from the Teflon membranes and transferred into sample jars. Samples for organic analyses were placed into precleaned glass jars and shipped on ice to the NWQL for analysis. Samples for inorganic analyses were placed into polypropylene jars, freeze-dried, and pulverized before they were shipped to the USGS Mineral Resources Program Analytical Laboratories in Lakewood, Colo.

Analytical Methods

Stream-sediment samples were analyzed for major and trace elements and halogenated organic compounds including pesticides, flame retardants, and PCBs. The USGS Mineral Resources Program Analytical Laboratories in Lakewood, Colo., analyzed the samples for major and trace elements. The NWQL analyzed the samples for halogenated organic compounds.

Freeze-dried stream-sediment samples were analyzed for major and trace elements by using several analytical methods. Total carbon was analyzed by combustion with an automated carbon analyzer following methods described by Brown and Curry (2002); carbonate carbon was determined as carbon dioxide by coulometric titration following methods described by Brown and others (2002). Organic carbon was computed by the laboratory as the difference between total carbon and carbonate carbon. Samples for major and trace element analyses were digested completely by a mixture of hydrochloric, nitric, perchloric, and hydrofluoric acids and analyzed by inductively coupled plasma-mass spectrometry (Briggs and Meier, 2002). Concentrations of mercury were determined by continuous flow-cold vapor-atomic fluorescence spectrometry (Hageman, 2007).

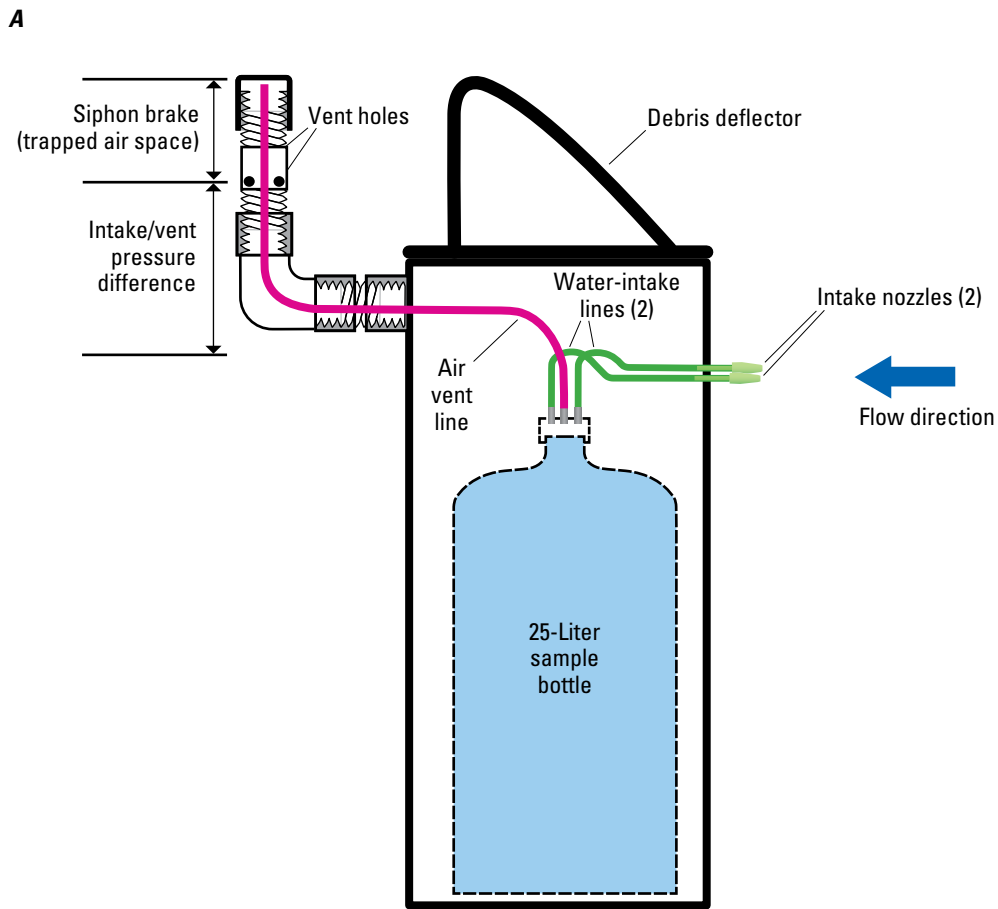

Figure 4. Suspended-sediment sample collection methods used at Leon Creek in San Antonio, Texas, 2012–14. *A*, Passive sampler used to collect suspended-sediment samples; *B*, Hydrologic technician removing bottles from passive samplers after a storm; and *C*, Suspended sediment isolated on a Teflon membrane after filtration of a stormwater-runoff sample.

Wet stream-sediment samples were analyzed for halogenated organic compounds following a custom analytical method. Custom methods are methods that do not have a published method report at the time of sample analysis. The custom analytical method was chosen to replicate the analytical methods used in the previous USGS study of Bexar County sediments (Wilson, 2011) so that data from the past and present studies could be combined for data exploration and interpretation. The samples were extracted twice: (1) by using the ASE 200 accelerated-solvent extraction system (Dionex, Sunnyvale, Calif.) at a pressure of 13,800 kilopascals with a water/isopropyl alcohol mixture (50:50, volume-to-volume ratio) at 120 °C, and (2) by using a water/isopropyl alcohol mixture (20:80, volume-to-volume ratio) at 200 °C for 40 minutes each. Surrogate compounds were added to the sample prior to extraction to monitor laboratory preparation, matrix effects (Rowe and others, 2005; Geboy and Engle, 2011), and method performance. The extracts were analyzed by capillary-column gas chromatography/mass spectrometry on an Agilent Technologies, Model 5975, with the mass spectrometer operated in the electron-capture, negative-ion mode by using ammonia as the reactant gas. The halogenated organic compounds were identified by selected-ion monitoring of the ions of interest (Mark Burkhardt and Steven Zaugg, U.S. Geological Survey, National Water Quality Laboratory, written commun., July 2007). The NWQL was initially unable to identify DDD, DDE, and DDT in several of the samples because of matrix interference, and no results were reported. At the request of the author, the analyst reviewed the gas chromatography/mass spectrometry output for the samples with unreported values for these compounds. The individual sample-extracted ion chromatogram was overlaid with the method spikes-extracted ion chromatogram, allowing the analyst to identify shifts in the retention time and signal-to-noise ratios for the responses. This allowed the analyst to identify the presence of DDD, DDE, and DDT in the samples where they were initially unable to identify these compounds and change the unreported values to less than values. The updated less than values were then verified by using gas chromatography/electron-capture detection analysis of the archived extracts (Mary Olson, U.S. Geological Survey, National Water Quality Laboratory, written commun., April 2014). The methods used for gas chromatography/electron-capture detection analysis are described in Noriega and others, 2003. The results were assigned an “h” value-qualifier code indicating the compounds were identified and then verified by this second method.

Quality Control

An assessment of data quality can be made based on the results of quality-control samples. Quality-control samples submitted to the analytical laboratories by project personnel included 7 streambed-sediment sample duplicates, 2 suspended-sediment sample duplicates, National Institute of Standards and Technology (NIST) reference material 8704

(Buffalo River Sediment; National Institute of Standards and Technology, 2000) for major and trace elements, and NIST standard reference material 1941b (Organics in Marine Sediment; National Institute of Standards and Technology, 2015) for pesticides and PCBs.

Duplicate samples are two samples that are considered to be essentially identical in composition and are used to provide information about variability in the sample collection and analytical processes (Mueller and others, 2015). Concurrent duplicate samples were collected from Leon Creek, meaning that two samples were collected by using identical methodology, and as closely together in time and space as possible (Horowitz and others, 1994). Duplicate sample results can be affected by sample heterogeneity, particularly when sediments are the sample media (Pirkey and Glodt, 1998). The relative percent difference (RPD) was calculated between each pair of sample results to provide a measure of variability by using the following equation:

$$RPD = \frac{|C_1 - C_2|}{(C_1 + C_2)/2} \times 100 \quad (1)$$

where

- C_1 is the constituent concentration in the first sample, and
- C_2 is the constituent concentration in the duplicate sample.

The RPDs of concentrations for inorganic and organic constituents are listed in table 3 (at end of report). The mean and median RPD between duplicate stream-sediment samples collected from Leon Creek in San Antonio during 2012–14 are summarized (table 4). The mean and median RPDs are similar for streambed- and suspended-sediment samples, indicating similar variability in the two sample collection processes. The comparison of duplicate sample results indicates greater variability in the halogenated organic compound

Table 4. The mean and median relative percent difference (RPD) between duplicate stream-sediment samples collected from Leon Creek in San Antonio, Texas, 2012–14.

Category	Number of samples	Mean RPD	Median RPD
All duplicate samples	9	13	2.8
Streambed-sediment samples	7	13	2.2
Suspended-sediment samples	2	12	6.5
Major and trace elements	9	5.1	2.0
Halogenated organic compounds	9	42	29
Pesticides	9	60	49
Brominated flame retardants	9	40	29
Polychlorinated biphenyls (PCBs)	9	18	1.6

12 Occurrence and Concentrations of Selected Trace Elements and Halogenated Organic Compounds in Stream Sediments

concentrations compared to the major and trace element concentrations. Within the halogenated organic compound duplicate sample results, the RPDs were greatest for the pesticides and lowest for the PCBs. The variability between sample types and analytical methods are similar to that of the previous USGS study of Bexar County sediments (Wilson, 2011, p. 19).

Comparisons of analyses of reference materials by the USGS laboratories to the NIST concentration values generally indicate negative bias (that is, the measured concentrations were likely less than the actual concentrations) and the possibility of false negatives (concentrations reported as less than the applicable reporting level when they were likely larger than the applicable reporting level) during environmental sample analyses (table 5). Results for the analysis of the reference material 8704 (Buffalo River Sediment) by the USGS Mineral Resources Program Analytical Laboratories were within the range of uncertainty for 28 percent of the analyses, greater than the range of uncertainty for 2 percent of the analyses, and less than the range of uncertainty for 70 percent of the analyses. The NWQL results for the analysis of the standard reference material 1941b (Organics in Marine Sediment) were adjusted for NWQL laboratory reagent spike recoveries before comparison to the NIST concentration values. After adjustment, the laboratory results were within the range of uncertainty for 18 percent of the analysis, greater than the range of uncertainty for 10 percent of the analyses, and less than the range of uncertainty (many of which were less than the applicable interim reporting level) for 72 percent of the analyses. The interim reporting level, hereinafter referred to as the “IRL,” is a temporary reporting level used for new or custom schedules when long-term method detection limit data are unavailable, and a laboratory reporting level has not yet been established (U.S. Geological Survey, 2002, table 5).

Quality control for the NWQL for the halogenated organic compound analyses consisted of analyzing a laboratory reagent blank and a laboratory reagent spike, along with monitoring recovery of surrogate compounds with each set of environmental samples. The samples collected from Leon Creek during 2012–14 were analyzed in eight different sets (table 6, at end of report). Halogenated organic compound concentrations less than their respective IRLs are hereinafter referred to as “nondetections” or “nondetected concentrations,” and concentrations equal to or greater than their respective IRLs are referred to as “detections” or “detected concentrations.”

Laboratory reagent blank samples are used to monitor for impurities and contamination from reagents and glassware (Noriega and others, 2003). Two to five halogenated organic compounds were detected in each of the blank samples (table 6). Polybrominated diphenyl ether (PBDE) congeners 47 and 99 were detected in all blank samples. PBDE congener 100 and hexachlorobenzene were also detected frequently in the blanks. PBDE congeners 47, 99, and 100 were frequently detected in the laboratory reagent blanks included with the

sediment samples in a previous USGS study of Bexar County sediments (Wilson, 2011). Whenever a halogenated organic compound was detected in a blank sample, the quantification of that same compound in the environmental samples from the same sample set was qualified as estimated with an “E” remark code and qualified as detected in the laboratory blank with a “v” value-qualifier code (Childress and others, 1999). Some of the detections of PBDE congeners 47, 99, and 100 in the blank samples were at concentrations greater than their IRL of 0.1 microgram per kilogram ($\mu\text{g}/\text{kg}$). Detections of halogenated organic compounds in blank samples, particularly at concentrations equal to or greater than their IRLs, indicate positive bias and the possibility of false positives during environmental sample analyses; however, the detections in the environmental samples were at concentrations 3 to 280 times higher than the detected concentrations in their respective set blanks. Because concentrations measured in the environmental samples were much larger compared to those measured in the blank samples, no environmental data were rejected or adjusted on the basis of the results obtained from blank samples.

On the basis of laboratory reagent spike recoveries, the analytical method performance and potential bias of environmental sample results were low compared to true environmental sample concentrations. The overall average spike recovery for the halogenated organic compounds was 73.5 percent. The NWQL establishes annually acceptable spike recovery ranges on the basis of historical spike analyses. Spike recoveries were within acceptable recovery ranges for 78.8 percent of the spike samples analyzed. Approximately three-fourths of the spike recoveries that were outside of their acceptable ranges were low. The compounds with the most frequent low spike recoveries were triclosan; PCB congeners 146, 174, 177, 194, 206; and pentabromotoluene. Low spike recoveries for the PCB congeners were not common (only one congener low in one spike sample) in the laboratory reagent spikes included with the sediment samples in the previous Bexar County sediment study (Wilson, 2011). The PBDE congener 47 was the compound with the most frequent high spike recovery (also detected in all of the blank samples).

The environmental sample results were adjusted for the laboratory reagent spike recoveries to assess the possible effect of the analytical method performance on the data interpretation. The environmental sample concentrations were raised or lowered as needed to represent a 100-percent spike recovery. Comparisons of the environmental sample concentrations among sites, sampling events, and to sediment-quality guidelines before and after spike adjustments indicated that the spike recovery rates had no apparent effect on the interpretation of the study results. The environmental sample results are therefore used in this report as received from the laboratory. Because laboratory reagent spikes are prepared using reagent water (deionized water that is continuously purged at the NWQL with ultrapure nitrogen and assumed to be void of the analytes of interest), any possible matrix effects associated with any organic matter, and (or) constituents other than the target constituent that might be present in the environmental samples,

Table 5. Comparison of U.S. Geological Survey (USGS) analytical laboratory results to the National Institute of Standards and Technology (NIST) reference materials.

[Reference material 8704 (Buffalo River Sediment) was used for the inorganic and carbon constituents; standard reference material 1941b (Organics in Marine Sediment) was used for the organic constituents; --, no data; <, less than; E, estimated; ±, plus or minus]

Constituent, units	Provider of reference material results and date of submittal to analytical laboratory		
	NIST	USGS	USGS
	--	11/28/2012	4/9/2013
Calcium, milligrams per kilogram	26,410 ± 830	23,000	25,000
Magnesium, milligrams per kilogram	12,000 ± 180	11,000	11,000
Potassium, milligrams per kilogram	20,010 ± 410	18,000	19,000
Sodium, milligrams per kilogram	5,530 ± 150	5,400	5,600
Carbon (inorganic plus organic), percent	3.351 ± 0.017	3.4	3.1
Aluminum, milligrams per kilogram	61,000 ± 1,800	59,000	60,000
Barium, milligrams per kilogram	413 ± 13	400	380
Cadmium, milligrams per kilogram	2.94 ± 0.29	2.9	3.0
Cesium, milligrams per kilogram	5.83 ± 0.12	5.60	5.70
Chromium, milligrams per kilogram	121.9 ± 3.8	110	110
Cobalt, milligrams per kilogram	13.57 ± 0.43	13	13
Iron, milligrams per kilogram	39,700 ± 1,000	36,000	38,000
Lead, milligrams per kilogram	150 ± 17	140	140
Manganese, milligrams per kilogram	544 ± 21	530	550
Nickel, milligrams per kilogram	42.9 ± 3.7	42	39
Scandium, milligrams per kilogram	11.26 ± 0.19	11	10
Titanium, milligrams per kilogram	4,570 ± 200	3,900	3,400
Vanadium, milligrams per kilogram	94.6 ± 4	90	86
Zinc, milligrams per kilogram	408 ± 15	380	380
Antimony, milligrams per kilogram	3.07 ± 0.32	2.8	2.6
Arsenic, milligrams per kilogram	17 ¹	16	15
<i>cis</i> -Chlordane, micrograms per kilogram	0.85 ± 0.11	<0.29 ²	0.09 ²
<i>cis</i> -Nonachlor, micrograms per kilogram	0.378 ± 0.053	<0.13 ²	E0.06 ²
<i>p,p'</i> -DDD, micrograms per kilogram	4.66 ± 0.46	<2.65 ²	<3.86 ²
<i>p,p'</i> -DDE, micrograms per kilogram	3.22 ± 0.28	<1.32 ²	0.31 ²
<i>p,p'</i> -DDT, micrograms per kilogram	1.12 ± 0.42	<4.42 ^{2,3}	<5.04 ^{2,3}
<i>trans</i> -Chlordane, micrograms per kilogram	0.566 ± 0.093	<0.27 ²	E0.09 ²
<i>trans</i> -Nonachlor, micrograms per kilogram	0.438 ± 0.073	<0.13 ²	<0.20 ²
PCB congener 101, micrograms per kilogram	5.11 ± 0.34	<2.12 ²	1.59 ²
PCB congener 110, micrograms per kilogram	4.62 ± 0.36	<2.1 ²	6.55 ²
PCB congener 118, micrograms per kilogram	4.23 ± 0.19	2.96 ²	E2.08 ²
PCB congener 138, micrograms per kilogram	3.6 ± 0.28	3.43 ²	4.88 ²
PCB congener 146, micrograms per kilogram	1.22 ± 0.12	1.24 ²	0.64 ²
PCB congener 149, micrograms per kilogram	4.35 ± 0.26	1.11 ²	2.07 ²
PCB congener 170, micrograms per kilogram	1.35 ± 0.09	1.84 ²	1.31 ²
PCB congener 174, micrograms per kilogram	1.51 ± 0.39	1.24 ²	E0.91 ²
PCB congener 180, micrograms per kilogram	3.24 ± 0.51	3.14 ²	E2.64 ²
PCB congener 183, micrograms per kilogram	0.979 ± 0.087	1.27 ²	E0.64 ²
PCB congener 187, micrograms per kilogram	2.17 ± 0.22	1.85 ²	E1.68 ²
PCB congener 194, micrograms per kilogram	1.04 ± 0.06	1.09 ²	E0.81 ²
PCB congener 206, micrograms per kilogram	2.42 ± 0.19	2.56 ²	E1.8 ²
PCB congener 49, micrograms per kilogram	4.34 ± 0.28	<4.3 ^{2,3}	<7.1 ^{2,3}
PCB congener 52, micrograms per kilogram	5.24 ± 0.28	<1.97 ²	<2.55 ²
PCB congener 70, micrograms per kilogram	4.99 ± 0.29	<3.59 ²	<5.8 ^{2,3}
Thorium, milligrams per kilogram	9.07 ± 0.16	9	8
Uranium, milligrams per kilogram	3.09 ± 0.13	3.0	2.7

¹Not enough data to assign uncertainty.

²Adjusted for spike recovery.

³Nondetection with reporting limit above the NIST concentration and range of uncertainty, not included in calculations of percentage of USGS results outside of the NIST range of uncertainty.

14 Occurrence and Concentrations of Selected Trace Elements and Halogenated Organic Compounds in Stream Sediments

are not accounted for by laboratory reagent spike recovery rates (Rowe and others, 2005).

Surrogate compounds are added to the environmental samples at the time of extraction and are used to monitor the recovery and matrix effects of the analytical method. Surrogate recoveries are not used to correct concentrations because the surrogates do not chemically mimic all of the compounds in the laboratory method (Noriega and others, 2003). The average surrogate recoveries were 54.5, 64.2, and 143.9 percent for 4,4'-dibromooctafluorobiphenyl, PCB congener 202-¹³C₁₂, and *p,p'*-DDT-*d*₈, respectively (table 7). Surrogate recovery control limits are established similarly to spike recoveries. Control limits define the range of acceptable surrogate recovery values for each compound (Noriega and others, 2003). Surrogate recoveries were within control limits of 20 to 104 percent for 4,4'-dibromooctafluorobiphenyl, 38 to 110 percent for PCB congener 202-¹³C₁₂, and 39 to 129 percent for *p,p'*-DDT-*d*₈ for 76 percent of the sample analyses. Most of the surrogate recoveries that were outside of the acceptable range exceeded the control limits for the *p,p'*-DDT-*d*₈ surrogate. The NWQL checks and adjusts the method when surrogate recoveries are outside of the control limits.

Several factors can affect the analytical results reported by the NWQL for organic compounds. The IRLs for organic compounds were raised as the sediment mass available for analysis decreased, resulting in higher IRLs for some suspended-sediment samples, in particular. The NWQL used an "E" remark code to signify that the concentration was an estimated value for one or more possible reasons, and for most samples, at least one constituent was estimated. When

an organic compound was detected in the blank sample, an "E" remark code and a "v" value-qualifier code were assigned to the results of that same compound in the environmental sample. Some organic compounds were assigned an "E" remark code and an "m" value-qualifier code because there was questionable precision or accuracy with the analytical method as a result of matrix interference or because they were highly variable compounds. Concentrations that were extrapolated because they were less than the lowest calibration standard, method range, or instrument range were assigned an "E" remark code and a "b" or "n" value-qualifier code (Childress and others, 1999).

Information obtained from all of the quality-control samples indicates the variability was high for the halogenated organic compound method, particularly for the pesticides; however, the amount of variability was considered typical for sediment samples based on a comparable previous study (Wilson 2011). The concentrations of the reference materials were lower than expected for the trace elements and organic compounds. There were frequent detections of flame retardants in the laboratory reagent blanks, which is typical for the analytical method. The laboratory reagent spike recoveries were unusually low for some of the PCB congeners. The quality-control data for trace elements indicate the concentrations measured for these constituents tend to be biased somewhat low but are considered acceptable. The quality-control data for organic compounds indicate there are bias and variability concerns associated with these data that must be considered when interpreting the results obtained from environmental samples.

Table 7. Surrogate recoveries in streambed- and suspended-sediment samples collected from sites on Leon Creek, San Antonio, Texas, 2012–14.[QC, quality control; NWQL, U.S. Geological Survey National Water Quality Laboratory; PCB, polychlorinated biphenyl; *p,p'*-DDT, para,para'-dichlorodiphenyl trichloroethane; SB, Bottom material; --, no data; SBQ, QC sample - Bottom material; SS, Suspended sediment; SSQ, QC sample - Suspended sediment]

Station number	Station name	Site identifier (table 1)	Date	Medium code (QC sample type)	NWQL set number	4,4'-dibromo-octafluoro-biphenyl, internal standard/surrogate (percent recovery)	PCB congener 202- ¹³ C ₁₂ ' surrogate (percent recovery)	<i>p,p'</i> -DDT- <i>d</i> ₈ ' surrogate (percent recovery)
08181435	Leon Creek at Loop 410 at San Antonio, Tex.	Loop 410	11/15/2012	SB	201234302	--	56.6	61.4
08181435	Leon Creek at Loop 410 at San Antonio, Tex.	Loop 410	11/15/2012	SBQ (replicate)	201234302	--	66.2	69.0
08181435	Leon Creek at Loop 410 at San Antonio, Tex.	Loop 410	01/09/2013	SS	201312803	--	59.9	83.5
08181435	Leon Creek at Loop 410 at San Antonio, Tex.	Loop 410	02/07/2013	SB	201312803	--	63.8	90.6
08181435	Leon Creek at Loop 410 at San Antonio, Tex.	Loop 410	02/07/2013	SBQ (replicate)	201316313	--	48.8	113
08181435	Leon Creek at Loop 410 at San Antonio, Tex.	Loop 410	04/29/2013	SS	201316313	--	58.0	171
08181435	Leon Creek at Loop 410 at San Antonio, Tex.	Loop 410	05/14/2013	SB	201316313	--	45.9	172
08181435	Leon Creek at Loop 410 at San Antonio, Tex.	Loop 410	05/14/2013	SBQ (replicate)	201320406	--	71.5	210
08181435	Leon Creek at Loop 410 at San Antonio, Tex.	Loop 410	05/24/2013	SS	201320406	--	78.7	261
08181435	Leon Creek at Loop 410 at San Antonio, Tex.	Loop 410	06/25/2013	SB	201326608	--	66.6	132
08181435	Leon Creek at Loop 410 at San Antonio, Tex.	Loop 410	06/25/2014	SS	201425501	81.7	78.0	97.7
08181435	Leon Creek at Loop 410 at San Antonio, Tex.	Loop 410	07/22/2014	SB	201432811	37.0	43.0	46.5
08181435	Leon Creek at Loop 410 at San Antonio, Tex.	Loop 410	07/22/2014	SBQ (replicate)	201432811	47.6	49.1	51.4
292443098364600	Leon Creek at Rodriguez Park, San Antonio, Tex.	Rodriguez Park	11/15/2012	SB	201234302	--	71.4	72.6
292443098364600	Leon Creek at Rodriguez Park, San Antonio, Tex.	Rodriguez Park	02/07/2013	SB	201312803	--	54.9	65.4
292443098364600	Leon Creek at Rodriguez Park, San Antonio, Tex.	Rodriguez Park	04/29/2013	SS	201316313	--	57.9	174
292443098364600	Leon Creek at Rodriguez Park, San Antonio, Tex.	Rodriguez Park	04/29/2013	SSQ (replicate)	201316313	--	59.9	187
292443098364600	Leon Creek at Rodriguez Park, San Antonio, Tex.	Rodriguez Park	05/14/2013	SB	201320406	--	85.1	289
292443098364600	Leon Creek at Rodriguez Park, San Antonio, Tex.	Rodriguez Park	05/24/2013	SS	201320406	0.0	74.9	257
292443098364600	Leon Creek at Rodriguez Park, San Antonio, Tex.	Rodriguez Park	06/24/2013	SB	201326608	--	74.7	144
292443098364600	Leon Creek at Rodriguez Park, San Antonio, Tex.	Rodriguez Park	06/25/2014	SS	201425501	80.8	94.9	112
292443098364600	Leon Creek at Rodriguez Park, San Antonio, Tex.	Rodriguez Park	07/21/2014	SB	201433804	49.4	51.3	58.4
292338098360501	Leon Creek at Morey Road, San Antonio, Tex.	Morey Road	11/15/2012	SB	201234302	--	70.8	77.0

16 Occurrence and Concentrations of Selected Trace Elements and Halogenated Organic Compounds in Stream Sediments

Table 7. Surrogate recoveries in streambed- and suspended-sediment samples collected from sites on Leon Creek, San Antonio, Texas, 2012–14.—Continued

[QC, quality control; NWQL, U.S. Geological Survey National Water Quality Laboratory; PCB, polychlorinated biphenyl; *p,p'*-DDT, para,para'-dichlorodiphenyl trichloroethane; SB, Bottom material; --, no data; SBQ, QC sample - Bottom material; SS, Suspended sediment; SSQ, QC sample - Suspended sediment]

Station number	Station name	Site identifier (table 1)	Date	Medium code (QC sample type)	NWQL set number	4,4'-dibromo-octafluoro-biphenyl, internal standard/surrogate (percent recovery)	PCB congener 202- ¹³ C ₁₂ ' surrogate (percent recovery)	<i>p,p'</i> -DDT- <i>d</i> ₈ ' surrogate (percent recovery)
292338098360501	Leon Creek at Morey Road, San Antonio, Tex.	Morey Road	01/09/2013	SS	--	Insufficient sediment	Insufficient sediment	Insufficient sediment
292338098360501	Leon Creek at Morey Road, San Antonio, Tex.	Morey Road	02/06/2013	SB	201312803	--	57.2	82.8
292338098360501	Leon Creek at Morey Road, San Antonio, Tex.	Morey Road	02/06/2013	SBQ (replicate)	201316313	--	60.0	202
292338098360501	Leon Creek at Morey Road, San Antonio, Tex.	Morey Road	04/29/2013	SS	201316313	--	57.8	155
292338098360501	Leon Creek at Morey Road, San Antonio, Tex.	Morey Road	05/13/2013	SB	201320406	--	81.1	290
292338098360501	Leon Creek at Morey Road, San Antonio, Tex.	Morey Road	05/24/2013	SS	201320406	--	72.1	260
292338098360501	Leon Creek at Morey Road, San Antonio, Tex.	Morey Road	05/24/2013	SSQ (replicate)	201320406	--	52.0	209
292338098360501	Leon Creek at Morey Road, San Antonio, Tex.	Morey Road	06/25/2013	SB	201320406	--	78.0	285
292338098360501	Leon Creek at Morey Road, San Antonio, Tex.	Morey Road	06/25/2013	SBQ (replicate)	201320406	--	74.4	275
292338098360501	Leon Creek at Morey Road, San Antonio, Tex.	Morey Road	06/25/2014	SS	201425501	82.0	98.9	119
292338098360501	Leon Creek at Morey Road, San Antonio, Tex.	Morey Road	07/21/2014	SB	201433804	53.2	56.0	68.7
292240098353600	Leon Creek at Lackland Air Force Base Golf Course, San Antonio, Tex.	Joint Base	11/16/2012	SB	201234302	--	77.9	82.7
292240098353600	Leon Creek at Lackland Air Force Base Golf Course, San Antonio, Tex.	Joint Base	11/16/2012	SBQ (replicate)	201234302	--	35.0	37.7
292240098353600	Leon Creek at Lackland Air Force Base Golf Course, San Antonio, Tex.	Joint Base	02/06/2013	SB	201312803	--	52.7	84.1
292240098353600	Leon Creek at Lackland Air Force Base Golf Course, San Antonio, Tex.	Joint Base	05/13/2013	SB	201316313	--	58.7	209
292240098353600	Leon Creek at Lackland Air Force Base Golf Course, San Antonio, Tex.	Joint Base	06/24/2013	SB	201320406	--	76.5	287
292240098353600	Leon Creek at Lackland Air Force Base Golf Course, San Antonio, Tex.	Joint Base	07/21/2014	SB	201433804	59.1	60.2	69.0
88480206	USGS Central Tex. PO at Ferguson Ln, Austin, Tex.	--	11/28/2012	SBQ (standard reference material)	201235310	--	73.2	104
88480206	USGS Central Tex. PO at Ferguson Ln, Austin, Tex.	--	04/09/2013	SBQ (standard reference material)	201316313	--	30.1	83.2

Concentrations and Occurrence of Selected Trace Elements and Halogenated Organic Compounds

Concentrations of selected trace elements and halogenated organic compounds in the stream-sediment samples (table 8, at end of report) were compared to the consensus-based sediment-quality guidelines (SQGs) published by MacDonald and others (2000) (table 9). The SQGs evaluate the potential toxicity of bed sediments to benthic biota (sediment-dwelling organisms). The guidelines were developed for streambed sediment but not for suspended sediment; however, the suspended-sediment sample concentrations were evaluated relative to SQGs to enable comparisons between sites. Two SQG concentration levels are used: (1) a lower level, the threshold effect concentration (TEC), below which harmful effects to benthic biota are

Table 9. The consensus-based sediment-quality guidelines of MacDonald and others (2000) that were used to evaluate the contaminant concentrations in streambed- and suspended-sediment samples collected from Leon Creek in San Antonio, Texas, 2012–14.

[mg/kg, milligram per gram; µg/kg, microgram per kilogram; DDD, dichlorodiphenyldichloroethane; DDE, dichlorodipenyldichloroethylene; DDT, dichlorodiphenyltrichloroethane; PCB, polychlorinated biphenyl]

Constituent	Threshold effect concentration	Probable effect concentration
Trace elements (mg/kg)		
Arsenic	9.79	33.0
Cadmium	0.99	4.98
Chromium	43.4	111
Copper	31.6	149
Lead	35.8	128
Mercury	0.18	1.06
Nickel	22.7	48.6
Zinc	121	459
Halogenated organic compounds (µg/kg)		
Chlordane ¹	3.24	17.6
Dieldrin	1.90	61.8
DDD	4.88	28.0
DDE	3.16	31.3
DDT	4.16	62.9
Total PCB ²	59.8	676

¹Chlordane concentrations are computed as the sum of *cis*-chlordane, *trans*-chlordane, *cis*-nonachlor, and *trans*-nonachlor.

²Total PCB concentrations are computed as the sum of the concentrations of the following 18 PCB congeners: 49, 52, 70, 101, 110, 118, 138, 146, 149, 151, 170, 174, 177, 180, 183, 187, 194, and 206.

not expected, and (2) a higher level, the probable effect concentration (PEC), above which harmful effects are expected to occur frequently. Samples with concentrations between the TEC and PEC are neither predicted to be toxic nor predicted to be nontoxic to benthic biota. The sediment screening levels used by the TCEQ's Ecological Assessment Program are identical to the PECs of MacDonald and others (2000) (Texas Commission on Environmental Quality, 2015). The occurrence of selected halogenated organic compounds was evaluated by assessing the frequency at which they were detected.

The passive suspended-sediment samplers did not always work correctly. For unknown reasons, the passive sampler at the Rodriguez Park site did not fill during the storm on January 9, 2013. There also was not enough sediment recovered after filtration for both inorganic and organic analyses of the samples collected from the Morey Road and Loop 410 sites during the storm on January 9, 2013. As a result, both samples were filtered by using only the stainless-steel filter holder because the organic contaminants were of primary interest in this study; neither of the samples was filtered with the acrylic filter holder for the major and trace elements. The NWQL requests 10 grams (g; dry mass) of sediment for the organic analyses to achieve the lowest reporting levels. The reporting levels of both samples were raised by the laboratory because of the low sample masses (0.15 g at Morey Road and 1.13 g at Loop 410). The small mass of sediment recovered from the Morey Road suspended-sediment sample, which was one order of magnitude lower than the mass of sediment recovered in all other suspended-sediment samples, resulted in very high reporting levels (raised three orders of magnitude). For this reason, the organic compound laboratory results for the Morey Road suspended-sediment sample collected during the storm on January 9, 2013, were rejected and are not included in this report.

Trace Elements

Trace elements in stream sediments are derived from naturally weathered rock and soil particles; they also may be derived from pesticides, paint, sewage, fertilizers, mining activities, and the burning of fossil fuels (Senesil and others, 1999). Consensus-based sediment-quality guidelines (MacDonald and others, 2000) (TECs and PECs) are depicted along with the concentrations of arsenic, cadmium, chromium, copper, lead, mercury, nickel, and zinc measured in environmental samples (fig. 5). No trace element concentrations were greater than the applicable PEC in any of the samples, and concentrations of copper, lead, and mercury were less than the applicable TEC in all samples. Chromium was most frequently detected at concentrations greater than the TEC (30 percent of all analyses). Arsenic, cadmium, and zinc were detected at concentrations greater than the TEC, albeit in a relatively low percentage of samples (between 4 and 18 percent). The percentage of samples with concentrations greater than the TEC for all eight trace elements was greatest at the Morey Road site (41 percent) followed by the Joint Base (27 percent), Rodriguez Park (18 percent), and Loop 410 (14 percent) sites.

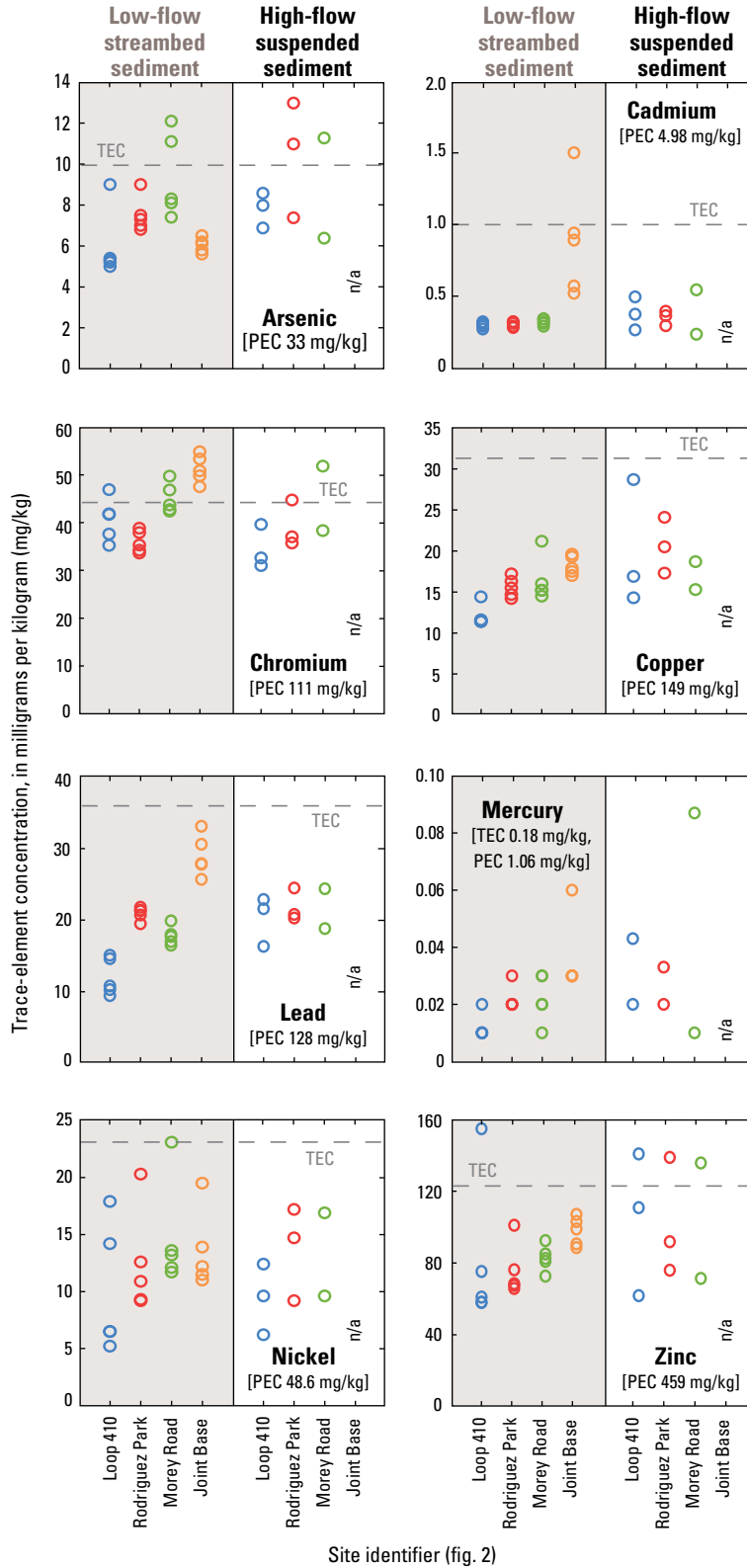

Figure 5. The comparison of consensus-based sediment-quality guidelines (MacDonald and others, 2000) with concentrations of trace elements in streambed- and suspended-sediment samples collected from Leon Creek, San Antonio, Texas, 2012–14.

Halogenated Organic Compounds

The halogenated organic compounds discussed in this report are associated with human activities, unlike the trace elements that can occur naturally. In the United States, the production, sale, or use of many of these compounds (certain pesticides, flame retardants, and PCBs) were banned or restricted because of their persistence in the environment, detrimental effects on plant and animal life, or both (Agency for Toxic Substances and Disease Registry, 1994, 2000, and 2015); other pesticides and flame retardants have not been banned or restricted at the time of this report (2016).

Concentrations of halogenated organic compounds can be related to the percentage of organic carbon in sediment samples because organic compounds sorb to the organic matter in sediments (Chiou and others, 1979; Karickhoff and others, 1979; Jones and de Voogt, 1999). The percentage of organic carbon is different in some of the streambed-sediment samples compared to the percentage of organic carbon in suspended-sediment samples collected from Leon Creek (fig. 6). Also, the percentages of organic carbon are generally lower in the streambed-sediment samples collected from the Loop 410 site compared to the percentages of organic carbon in streambed-sediment samples collected from downstream sites. A Kruskal-Wallis analysis of variance test (Iman and Conover, 1983) was used to determine that the percentages of organic carbon in the samples collected from each site have equivalent distributions; the attained significance level (p-value) was 0.27. Because the percentage of organic carbon did not vary significantly (p-value less than 0.05 is statistically significant) among the samples from the eight sites in the watershed, the concentrations of halogenated organic compounds were not normalized for organic carbon.

Pesticides

The pesticides assessed in this study are synthetic, halogenated organic compounds. The chlordane compounds (*cis*-chlordane, *trans*-chlordane, *cis*-nonachlor, and *trans*-nonachlor), which were banned in 1988 (Agency for Toxic Substances and Disease Registry, 1994), were the most frequently detected pesticides; they were detected in 84 percent of the samples and at every sample collection site (fig. 7). The samples with the largest number of pesticide compounds detected were collected from the Rodriguez Park

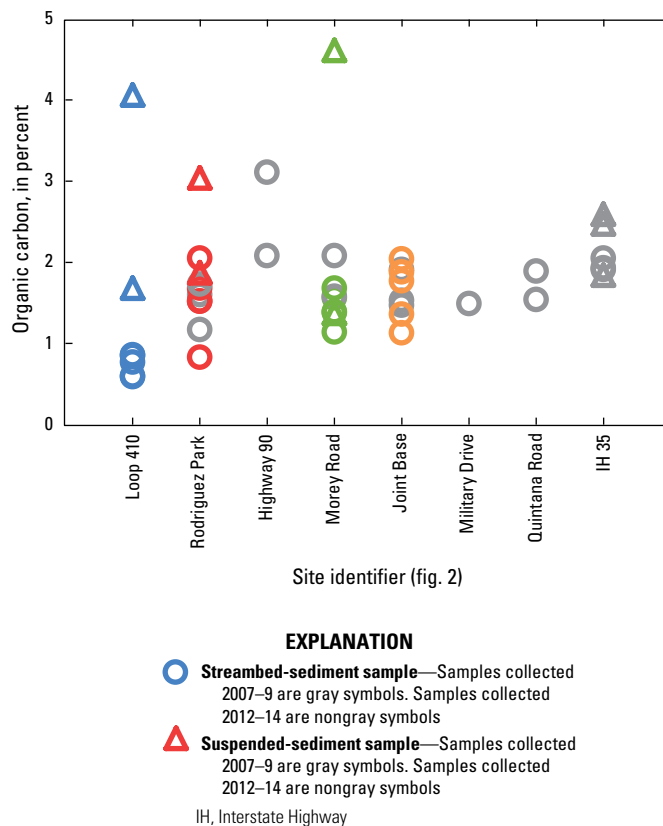

Figure 6. The percentage of organic carbon in streambed- and suspended-sediment samples collected from Leon Creek, San Antonio, Texas, 2007–9 and 2012–14.

site; however, it should be considered that three fewer samples were collected from the Joint Base site compared to all other sites. Neither dichlorodiphenyltrichloroethane (DDT) nor its breakdown products, DDD and DDE, were detected in the samples collected from the Loop 410 site; however they were found in samples collected from the sites downstream. Cyfluthrin, a synthetic pyrethroid insecticide, was the most frequently detected pesticide and was not banned for use at the time of sample collection; it was found in 53 percent of the samples and at every sample collection site. Overall, there were fewer detections of the pesticides that are not banned compared to the banned or restricted-use pesticides in the samples collected from every site except Loop 410.

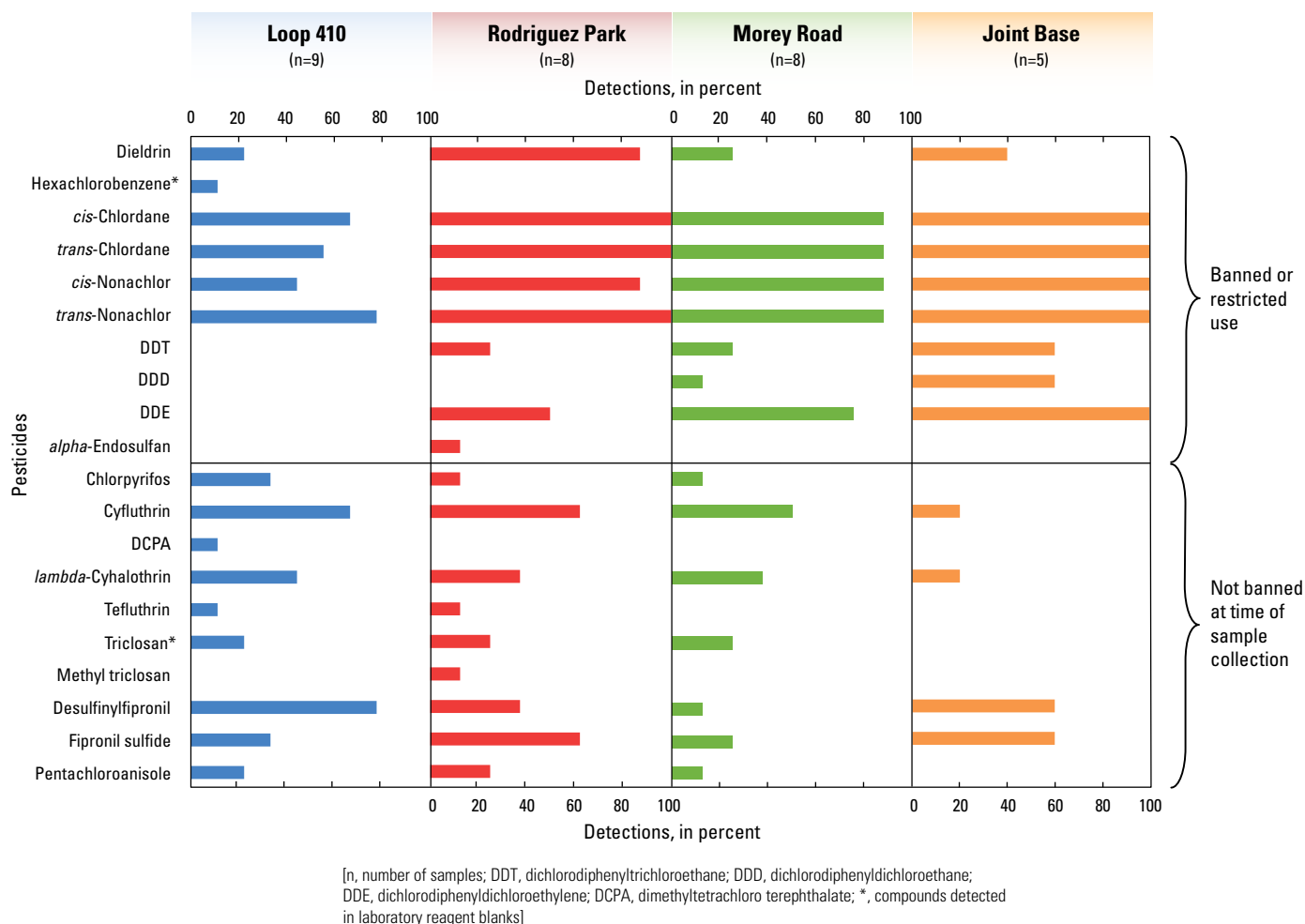

Figure 7. Detection frequencies of pesticides in streambed- and suspended-sediment samples, by site (table 1), collected from Leon Creek, San Antonio, Texas, 2012–14.

Concentrations of chlordane, dieldrin, DDD, DDE, and DDT measured in sediment samples were compared to the consensus-based SQGs in MacDonald and others (2000) (table 9). Chlordane concentrations, which were computed as the sum of *cis*-chlordane, *cis*-nonachlor, *trans*-chlordane, and *trans*-nonachlor, were greater than the TEC for 23 percent of the stream-sediment samples (fig. 8). The concentration of chlordane exceeded the TEC most frequently in the streambed-sediment samples collected from the Joint Base site. All of the dieldrin concentrations in the stream-sediment samples collected from Leon Creek were less than the TEC value of 1.9 µg/kg (table 8). The concentration of DDD exceeded the TEC in three samples with one sample collected from the Joint Base site greater than the PEC. All of the samples collected from the Joint Base site had concentrations of DDE greater than the TEC but less than the PEC. Three

samples collected from the Joint Base site had concentrations of DDT greater than the TEC with two of those concentrations also greater than the PEC. None of the samples collected from the Loop 410, Rodriguez Park, or Morey Road sites had DDD, DDE, or DDT concentrations greater than the TEC.

In short, pesticides that have been banned for several decades are commonly detected in Leon Creek stream sediments, particularly the chlordane compounds. Most of the pesticide concentrations were low except for some samples collected from the Joint Base site, where DDD and DDT were found at levels greater than the higher SQG (PEC). Whereas the frequent detections of pesticides in the Leon Creek stream sediments are notable, the few concentrations that exceed higher SQGs at the Joint Base site are of most concern.

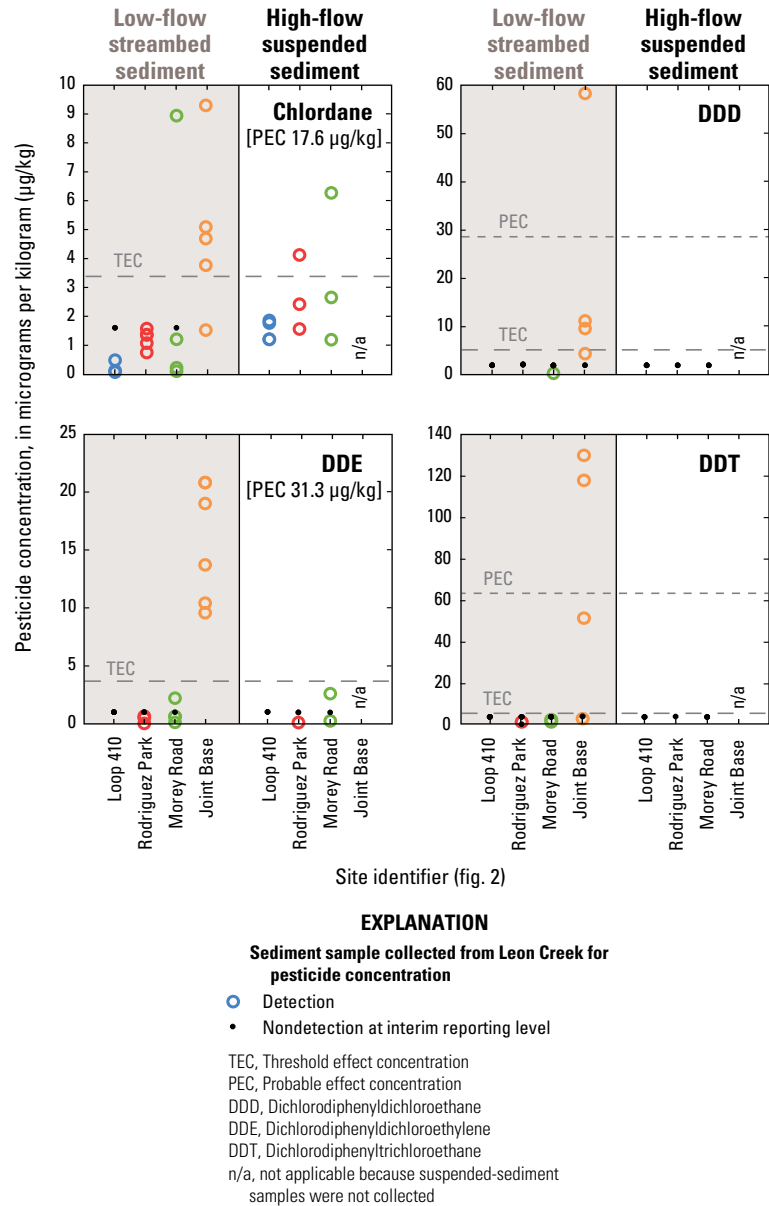

Figure 8. The comparison of consensus-based sediment-quality guidelines (MacDonald and others, 2000) with concentrations of pesticides in streambed- and suspended-sediment samples collected from Leon Creek, San Antonio, Texas, 2012–14.

Flame Retardants

Brominated flame retardants are halogenated organic compounds that are added to plastics, foams, and fabrics to increase the fire resistance of products such as electronics, automobiles, clothing, and furniture. The compounds are not chemically bound to the products to which they are added, making them likely to leach out of these products. Many brominated flame retardants are persistent toxic chemicals that bioaccumulate (Segev and others, 2009). In 2006, the U.S. Environmental Protection Agency restricted the manufacturing, importing, or

processing of pentabromodiphenyl ether (pentaBDE) and octabromodiphenyl ether (octaBDE), which are commercial mixtures of PBDE congeners (U.S. Environmental Protection Agency, 2014). The stream-sediment samples collected from Leon Creek during 2012–14 were analyzed for 10 PBDE congeners plus 3 other brominated flame retardants: dechlorane plus, pentabromotoluene, and 1,2-bis(2,4,6-tribromophenoxy) ethane (TBE). Brominated flame retardants were found at every site on Leon Creek where stream sediments were collected (fig. 9); however, some compounds (PBDEs 47, 99, and 100) were frequently detected in the laboratory reagent blanks so their detections

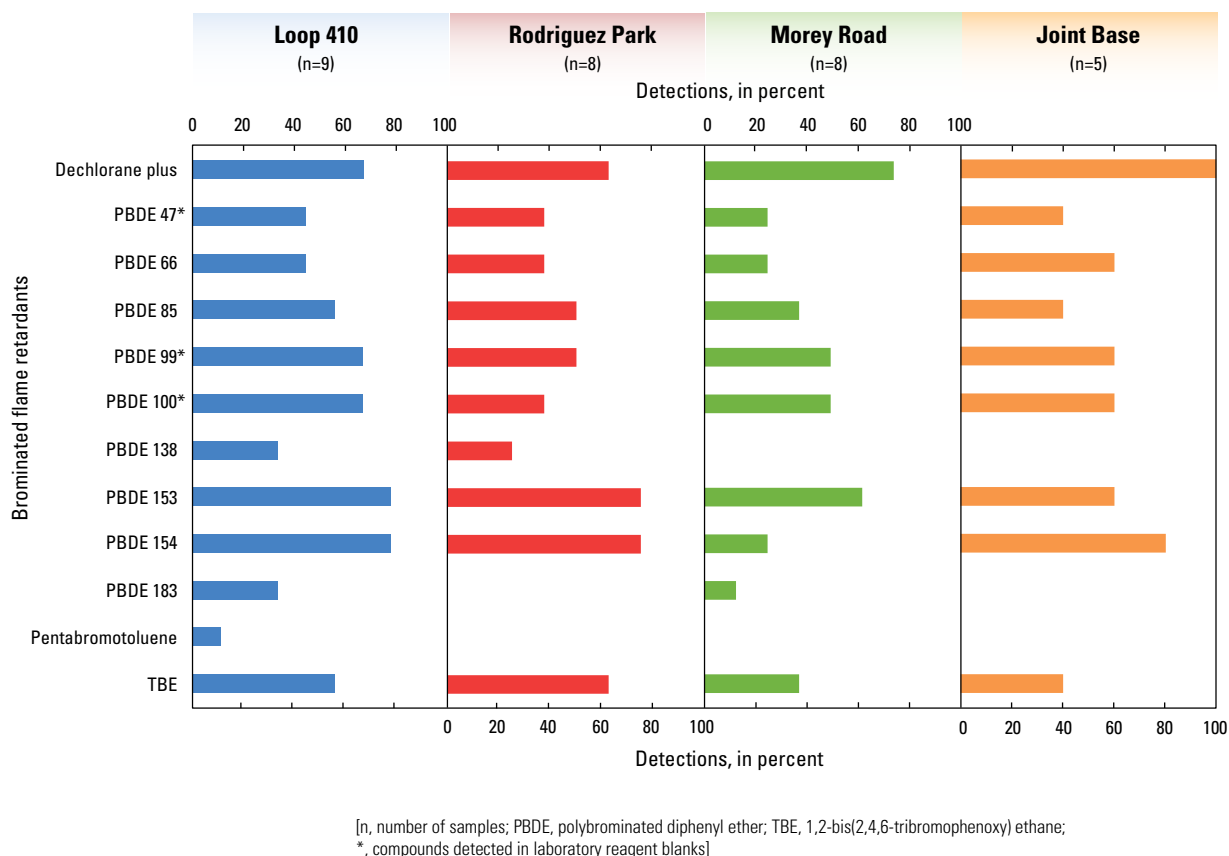

Figure 9. Detection frequencies of brominated flame retardants in streambed- and suspended-sediment samples, by site (table 1), collected from Leon Creek, San Antonio, Texas, 2012–14.

in the environmental samples may not be from local sources. Dechlorane plus and PBDE 153 were the most frequently detected compounds.

Consensus-based SQGs were not available for brominated flame retardants so samples were compared to Environment Canada Federal Environmental Quality Guidelines (FEQGs), which were developed for the protection of benthic and pelagic aquatic life (Environment Canada, 2013). Environment Canada recommended an FEQG of 0.4 µg/kg for PBDE congeners 99 and 100. The concentrations of PBDE 99 exceed the FEQG in two streambed-sediment samples collected from the Loop 410 site and three streambed-sediment samples collected from the Joint Base site (fig. 10). The concentrations of PBDE 99 exceed the FEQG in all of the suspended-sediment samples. The concentrations of PBDE 100 are less than the FEQG in all of the streambed-sediment samples. All of the suspended-sediment samples except one collected from the Morey Road site have concentrations of PBDE 100 greater than the FEQG. The concentrations of PBDE 99 and PBDE 100 generally were greater in the suspended-sediment samples collected during high flow compared to the concentrations of these constituents measured in streambed-sediment samples collected during low flow.

Although flame retardants were frequently detected in the Leon Creek stream-sediment samples at all sites, there may be some laboratory contamination for PBDEs 47, 99, and 100 based on the detections of these constituents in the laboratory reagent blanks. The concentrations of flame retardants generally were greater in the suspended-sediment samples than the streambed-sediment samples and were greater than the FEQG in many cases. Flame retardants in Leon Creek stream sediments are of moderate concern based on their frequent occurrence and concentrations in suspended sediments.

Polychlorinated Biphenyls

Polychlorinated biphenyls were first synthesized in the early 1930s and have had widespread industrial uses, primarily as plasticizers, hydraulic lubricants, and dielectric fluids in electrical capacitors (Smith and others, 1988). Adverse human-health effects and cancer in animals have been associated with exposure to PCBs. PCBs have not been manufactured in the United States since 1977, and their use was banned in 1979 (Agency for Toxic Substances and Disease Registry, 2000). PCBs consist of as many as 209 theoretically possible congeners, with various numbers and positions of chlorine

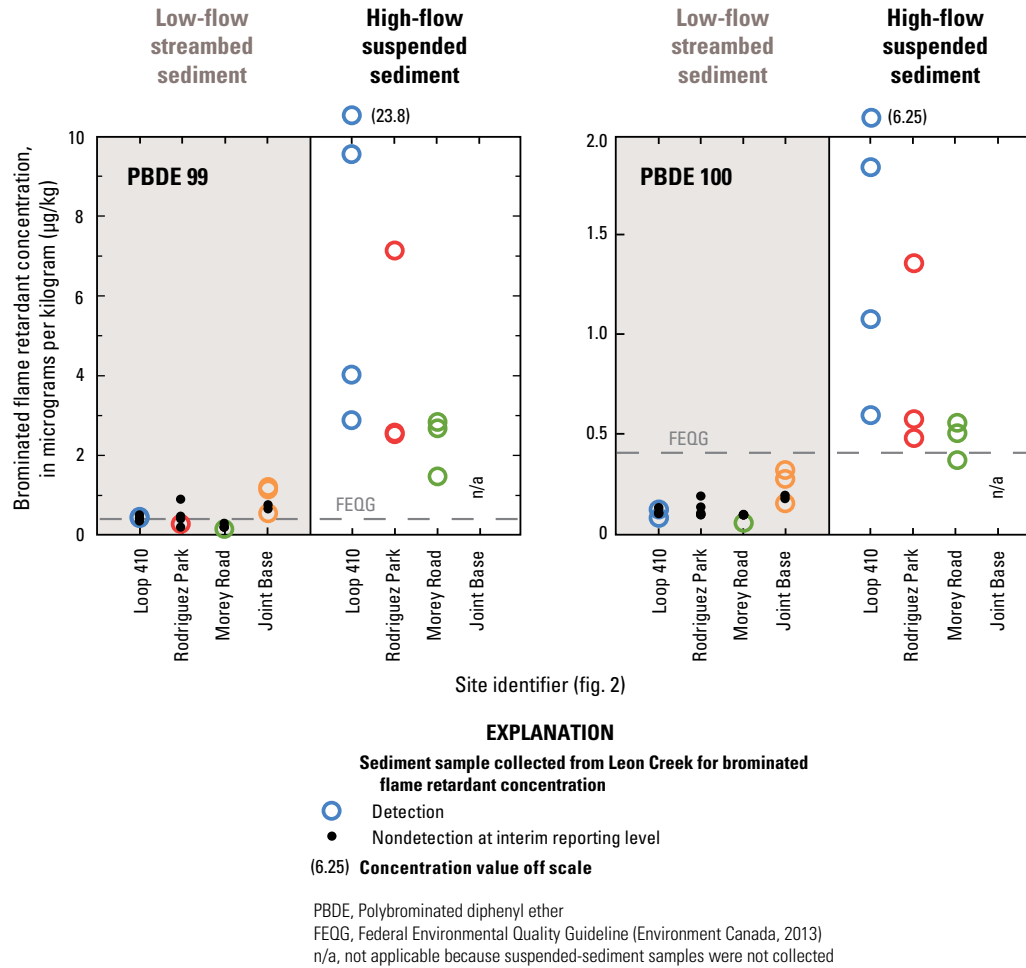
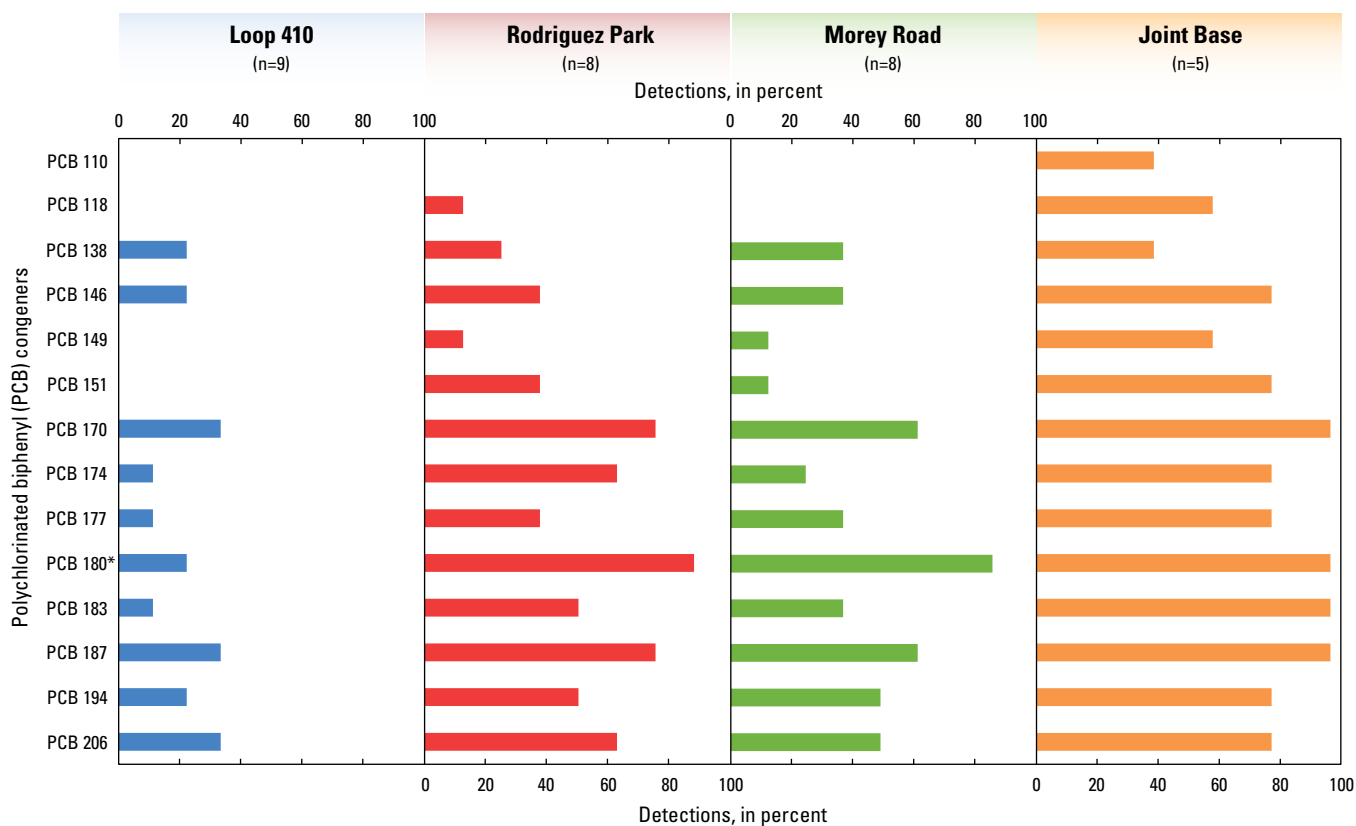

Figure 10. The comparison of Environment Canada (2013) Federal Environmental Quality Guidelines with concentrations of brominated flame retardants in streambed- and suspended-sediment samples collected from Leon Creek, San Antonio, Texas, 2012–14.

atoms attached to the biphenyl structure. Each congener has been assigned a congener number that generally increases with increasing chlorination of the biphenyl structure (Ballschmiter and Zell, 1980). Larger congeners tend to sorb strongly to solids such as sediments, whereas smaller congeners are more likely to volatilize (Eisenreich and others, 1983; Eisenreich and others, 1992; Pearson and others, 1996). The NWQL quantified 18 common PCB congeners in the stream-sediment samples collected from Leon Creek during 2012–14. The smaller PCB congeners (49, 52, 70, and 101) were not detected in any of the stream-sediment samples collected from Leon Creek (table 8). PCB congener 110 was detected only in samples collected from the Joint Base site, and PCB 118 was detected only in samples collected from the Rodriguez Park and Joint Base sites (fig. 11). PCB congeners 149 and 151 were not detected in any samples collected from the Loop 410 site but were detected at the three other sites. PCB congeners 170 through 206 were detected at all four

sites, with the most detections in the Joint Base samples and the fewest detections in the Loop 410 samples. Overall, the samples collected from the Joint Base site had the most PCB congener detections.

MacDonald and others (2000) published consensus-based SQGs for total PCBs (table 9). Total PCBs in the Leon Creek stream-sediment samples were computed as the sum of the 18 reported congeners (table 8) by using the Kaplan-Meier method for computing summations that include nondetections (Helsel, 2009). The Kaplan-Meier method is a nonparametric statistical method that was developed for evaluating right-censored survival data of people older than a certain age in medical and industrial statistics that has been modified for left-censored environmental data where nondetections are common. Right and left censored refers to a statistical treatment of extreme values. In right censoring, a data point larger than a certain value of “X” is replaced with a value of “greater than X,” whereas in left censoring,



[n, number of samples; *, compound detected in a laboratory reagent blank]

Figure 11. Detection frequencies of polychlorinated biphenyl congeners in streambed- and suspended-sediment samples, by site (table 1), from Leon Creek, San Antonio, Texas, 2012–14.

a data point smaller than a certain value of “Y” is replaced with a value of “less than Y.” The Kaplan-Meier method computes the cumulative distribution function for estimating sums, means, and variances of a dataset with nondetections. All concentrations of total PCBs in the stream-sediment samples collected from Leon Creek during 2012–14 are much smaller than the TEC of 59.8 $\mu\text{g}/\text{kg}$ (table 9). When detected, the concentrations of total PCBs in the stream-sediment samples collected from Leon Creek during 2012–14 ranged from an estimated 0.2 to 8.7 $\mu\text{g}/\text{kg}$ (table 8).

Briefly, PCBs (particularly the large congeners) were detected occasionally in samples collected from the Loop 410 site, commonly at the Rodriguez Park and Morey Road sites, and frequently at the Joint Base site. All of the PCB detections were at very low concentrations, about an order of magnitude lower than the lower SQG (TEC). However, results from the quality-control samples indicated negative or low bias (tables 5 and 6) for the PCB congener concentrations, which may have resulted in slightly lower reported concentrations than actual environmental concentrations.

Potential Sources of Polychlorinated Biphenyls

This report focuses primarily on PCBs because concentrations in Leon Creek are greater than other streams in Bexar County (Wilson, 2011), and fish consumption advisories in Leon Creek have been linked to PCBs (Texas Department of State Health Services, 2010). Sediment samples collected from Leon Creek by the USGS during 2007–9 and 2012–14 at a total of eight sites (fig. 2) following identical field and laboratory methods were evaluated to determine if potential PCB sources could be identified.

Modern releases of PCB to the environment have essentially stopped since manufacturing ceased in 1977 (Agency for Toxic Substances and Disease Registry, 2000), and present-day detections of PCBs are often derived from areas of historical PCB contamination. The compositions of PCB mixtures in the environment can be affected by processes such as volatilization, chemical or biological transformation, and bioaccumulation. The lower chlorinated congeners

are more susceptible to alteration than higher chlorinated congeners because of differences in chemical properties such as solubility, partition coefficients, and vapor pressures (Agency for Toxic Substances and Disease Registry, 2000). Previous studies of PCB degradation in stream sediments indicate concentrations can be appreciably lower after one to two decades (Van Metre and others 1998; Sinkkonen and Paasivirta, 2000). The alteration of PCB mixtures in the environment is a concern when comparing recent to historical levels; however, this same issue does not persist when comparing samples collected within the same decade.

Total PCB concentrations in the streambed-sediment samples collected from Loop 410 downstream to Morey Road were less than the PCB reporting levels or low relative to total PCB concentrations measured in samples collected from sites farther downstream (fig. 12). Lower total PCB concentrations were measured in the suspended-sediment samples collected from the Loop 410, Rodriguez Park, and Morey Road sites upstream from the Joint Base compared to the total PCB concentrations measured in suspended-sediment samples collected from the IH 35 site. There appears to be an additional source of PCBs to the stream sediments between the Morey Road and the Joint Base sample collection sites based on the higher total PCB concentrations in the stream-sediment samples collected from the Joint Base, Military Drive, Quintana Road, and IH 35 sites. Only low concentrations were measured in the samples collected from the catchment areas upstream from the Morey Road site.

Patterns of PCB congener concentrations can indicate sources, and potential sources to the Leon Creek stream sediments were explored by comparing the relative distributions of congeners in the sediment samples (Colman, 2000; Johnson and others, 2000; Cabela and others, 2002). Samples with no detections of any PCB congeners were excluded; only 40 of the 49 samples remained for comparison. Congener proportions were computed by dividing the individual PCB congener concentrations by the sum of the detected PCB congeners. Examples of PCB congener patterns in the sample with the greatest number of congener detections collected at each site are provided in figure 13. PCB congeners 138 and 180 dominated the PCB mixtures. PCB congener 138 represented the greatest proportion of the PCB mixture in 35 percent, and PCB congener 180 represented the greatest proportion of the mixture in 50 percent of the samples collected from the Loop 410, Rodriguez Park, Highway 90, and Morey Road sites. PCB congener 138 constituted the greatest proportion of the PCB mixture in 13 percent, and PCB congener 180

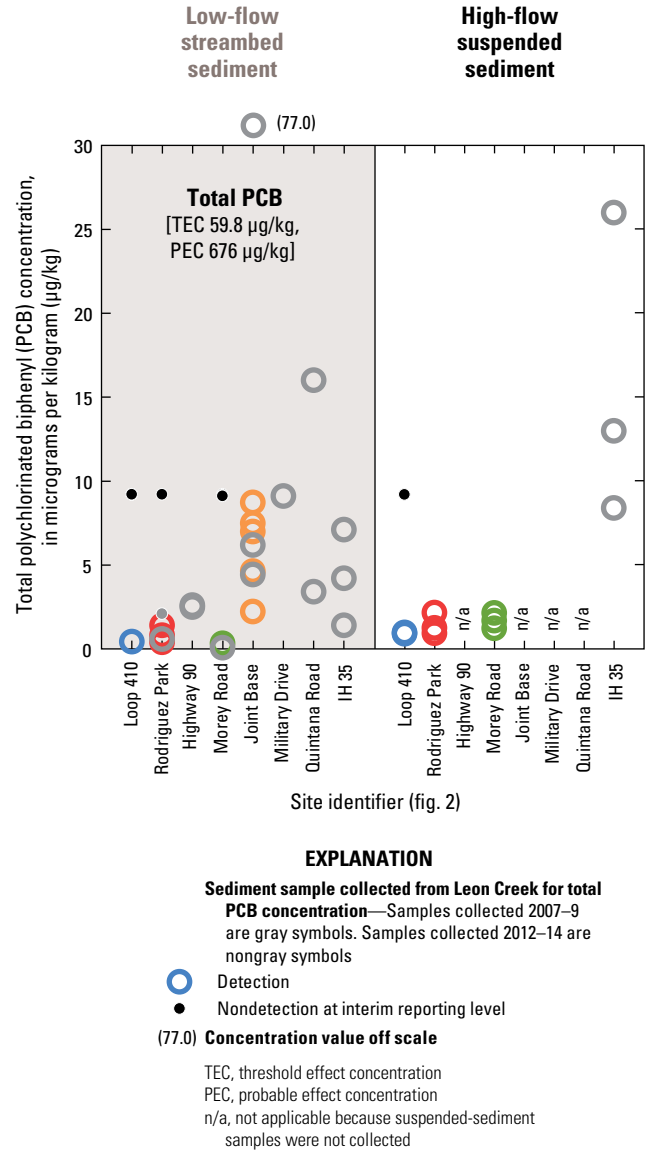

Figure 12. Concentrations of total polychlorinated biphenyls in streambed- and suspended-sediment samples collected from Leon Creek, San Antonio, Texas, 2007–9 and 2012–14.

constituted the greatest proportion of the PCB mixture in 80 percent of the samples collected from the Joint Base, Military Drive, Quintana Road, and IH 35 sites. Five samples without a single dominant congener, such as the sample collected at Joint Base on December 3, 2007 (fig. 13), were not included in the previous summary statistics.

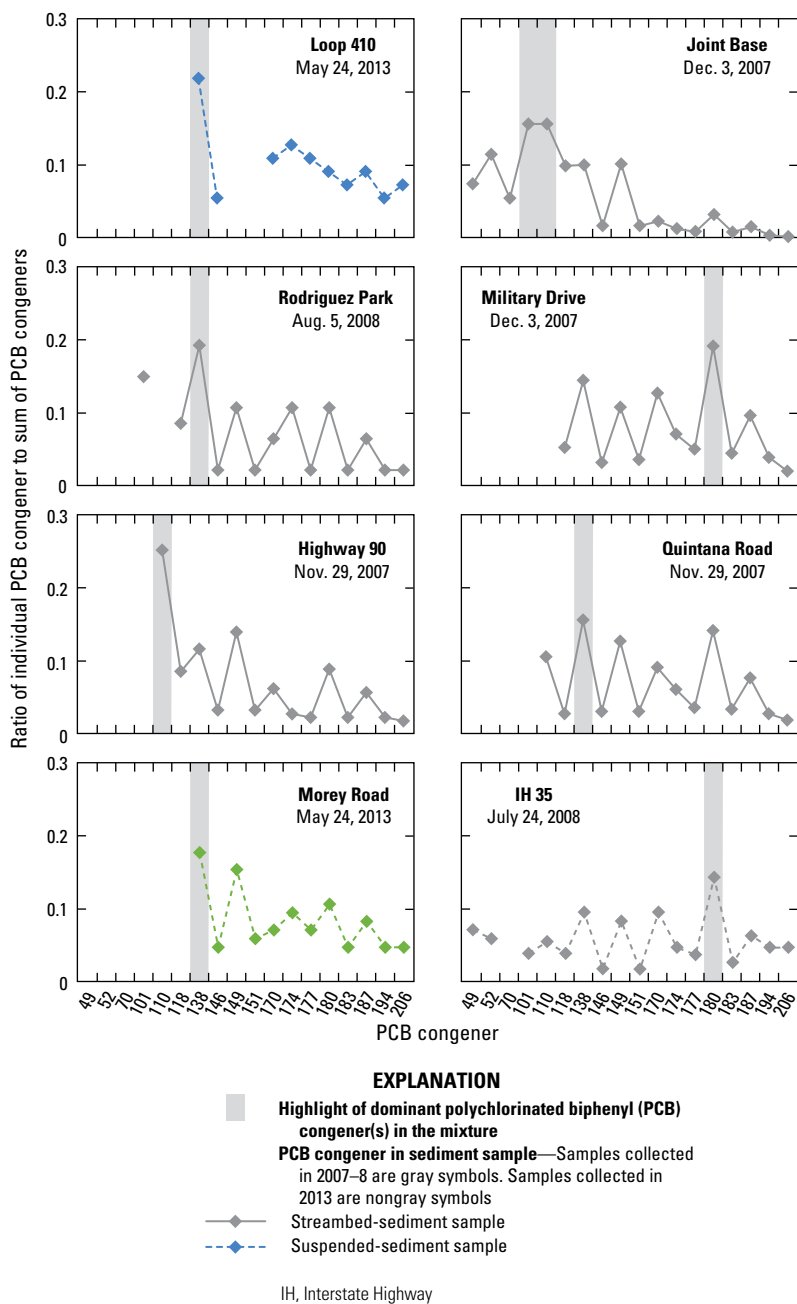

Figure 13. Examples of polychlorinated biphenyl congener concentrations normalized to the sum of the detected congener concentrations in selected stream-sediment samples collected from Leon Creek, San Antonio, Texas, 2007–9 and 2012–14.

Based on PCB congener patterns, there is a slight difference in the PCB mixtures in the samples collected upstream from the Joint Base compared to samples collected on and downstream from the base, which may be indicative of different PCB sources to the sites. The differences correspond to the increase in total PCBs at the Joint Base site compared to the sites upstream. Differences between PCB mixtures at the Leon Creek stream-sediment-sampling sites were evaluated statistically by computing the X^2 test statistic (Haan, 1977) between the proportional PCB congener profiles of selected samples following the approach of Van Metre and Mahler (2014). The X^2 is computed as the summation of the squared difference divided by the mean for each of the PCB congeners in a sample pair; the higher the X^2 , the more different the PCB mixtures (table 10). Nineteen of 49 samples were eliminated from compared sample data because the PCB congener concentrations frequently were less than the IRLs. Congeners were eliminated from compared sample

data if the concentration of a congener was less than the IRL in any sample, which resulted in the use of PCB congeners 170, 180, 187, and 206. It is unfortunate that PCB congener 138 was eliminated from the compared sample data because it was important when identifying differences in the congener patterns; however, the congener was not detected in 30 of the 49 samples in the compared sample data, making it useless during computations of the X^2 test statistic. The mean X^2 test statistic was greatest (PCB mixtures different) between the samples collected from the Loop 410 and Military Drive sites (0.228 ± 0.13), Loop 410 and Quintana Road sites (0.210 ± 0.08), and Loop 410 and Joint Base sites (0.205 ± 0.08) (table 11). The mean X^2 test statistic was lowest (PCB mixtures similar) between the samples collected from the Quintana Road and Military Drive sites (0.030 ± 0.03), Joint Base and Quintana Road sites (0.034 ± 0.04), and Highway 90 and Quintana Road sites (0.037 ± 0.02).

Table 11. Summary of mean and standard deviation (mean ± standard deviation) of Chi-square (X²) test statistics between proportional polychlorinated biphenyl (PCB) congener¹ profiles of stream-sediment samples collected from sites on Leon Creek, San Antonio, Texas, 2007–9 and 2012–14.

[±, plus or minus; --, no data because single sample; greatest mean X² test statistics highlighted in tan; lowest mean X² test statistics highlighted in green]

	Site identifier (fig. 2)							
	Loop 410	Rodriguez Park	Highway 90	Morey Road	Joint Base	Military Drive	Quintana Road	IH 35
Loop 410	0.149 ± 0.00	0.132 ± 0.12	0.124 ± 0.05	0.094 ± 0.06	0.205 ± 0.08	0.228 ± 0.13	0.210 ± 0.08	0.180 ± 0.08
Rodriguez Park		0.107 ± 0.14	0.067 ± 0.11	0.074 ± 0.07	0.110 ± 0.13	0.146 ± 0.18	0.108 ± 0.13	0.095 ± 0.09
Highway 90			0.038 ± 0.00	0.058 ± 0.03	0.045 ± 0.03	0.061 ± 0.03	0.037 ± 0.02	0.060 ± 0.06
Morey Road				0.047 ± 0.04	0.115 ± 0.06	0.170 ± 0.03	0.118 ± 0.03	0.075 ± 0.04
Joint Base					0.055 ± 0.06	0.048 ± 0.06	0.034 ± 0.04	0.085 ± 0.08
Military Drive						--	0.030 ± 0.03	0.134 ± 0.11
Quintana Road							0.038 ± 0.00	0.081 ± 0.07
IH 35								0.081 ± 0.08

¹PCB congeners 170, 180, 187, and 206.

Polychlorinated biphenyls were sold commercially as mixtures of congeners named Aroclors. Three of the most commonly produced and used Aroclors were 1242, 1254, and 1260. The last two digits of the Aroclor number indicate the approximate chlorine content by weight percentage, which is relevant to their potential for environmental degradation (Agency for Toxic Substances and Disease Registry, 2000). Aroclor 1242 was widely used, mostly in industrial applications such as transformers, hydraulic fluids, lubricants, and plasticizers. Aroclor 1254 was also widely used in the same industrial application as Aroclor 1242, plus several miscellaneous applications such as sealants, pesticides, cutting oils, and inks. Aroclor 1260 was commonly used in transformer fluids, hydraulic fluids, synthetic resins, and dedusting agents. On an overall basis, Aroclors 1242 and 1254 were more widely used in manufacturing applications compared to Aroclor 1260 (International Agency for Research on Cancer, 1978). Despite its relatively limited use, Aroclor 1260 was detected more frequently than Aroclors 1242 and 1254 in fish samples collected in 2002 from three sites in the study area (Highway 90, Joint Base, and Military Drive; Texas Department of Health, 2003). Frame and others (1996) determined the PCB congener distributions of several Aroclor mixtures. The PCB congener mixtures in the stream-sediment samples collected from Leon Creek during 2007–9 and 2012–14 were compared to Aroclors 1242, 1254, and 1260

to identify similarities in the congener patterns (fig. 14). The PCB congener pattern in the Leon Creek samples is most like the congener mixture in Aroclor 1260, which is chemically similar to the PCBs detected in the fish samples that resulted in the 2003 fish consumption advisory. Nonetheless, the types of Aroclors used in different catchment areas are not known, and it remains unclear whether the similarity between Aroclors and sediment samples is related to historical use or environmental degradation of the lower chlorinated congeners.

The PCB congener mixtures were chemically distinct and significantly different based on the X² test results for the samples collected from sites upstream from the Joint Base compared to the samples collected from sites on and downstream from the Joint Base. There were several data limitations that inhibited further exploration of the PCB sources to Leon Creek stream sediments in this study. First, there is little knowledge about the potential sources of PCBs in the Leon Creek catchment areas. Several potential PCB sources have been identified in the Leon Creek catchment areas (abandoned municipal landfills and industrial wastewater outfalls, for example); however, PCB mixtures from the potential sources have not been evaluated in a way that would facilitate linking PCBs at the sampling sites in this study to potential sources. Second, there are numerous nondetections in the Leon Creek stream-sediment laboratory results, and many of the IRLs are higher than the reported detections. Datasets

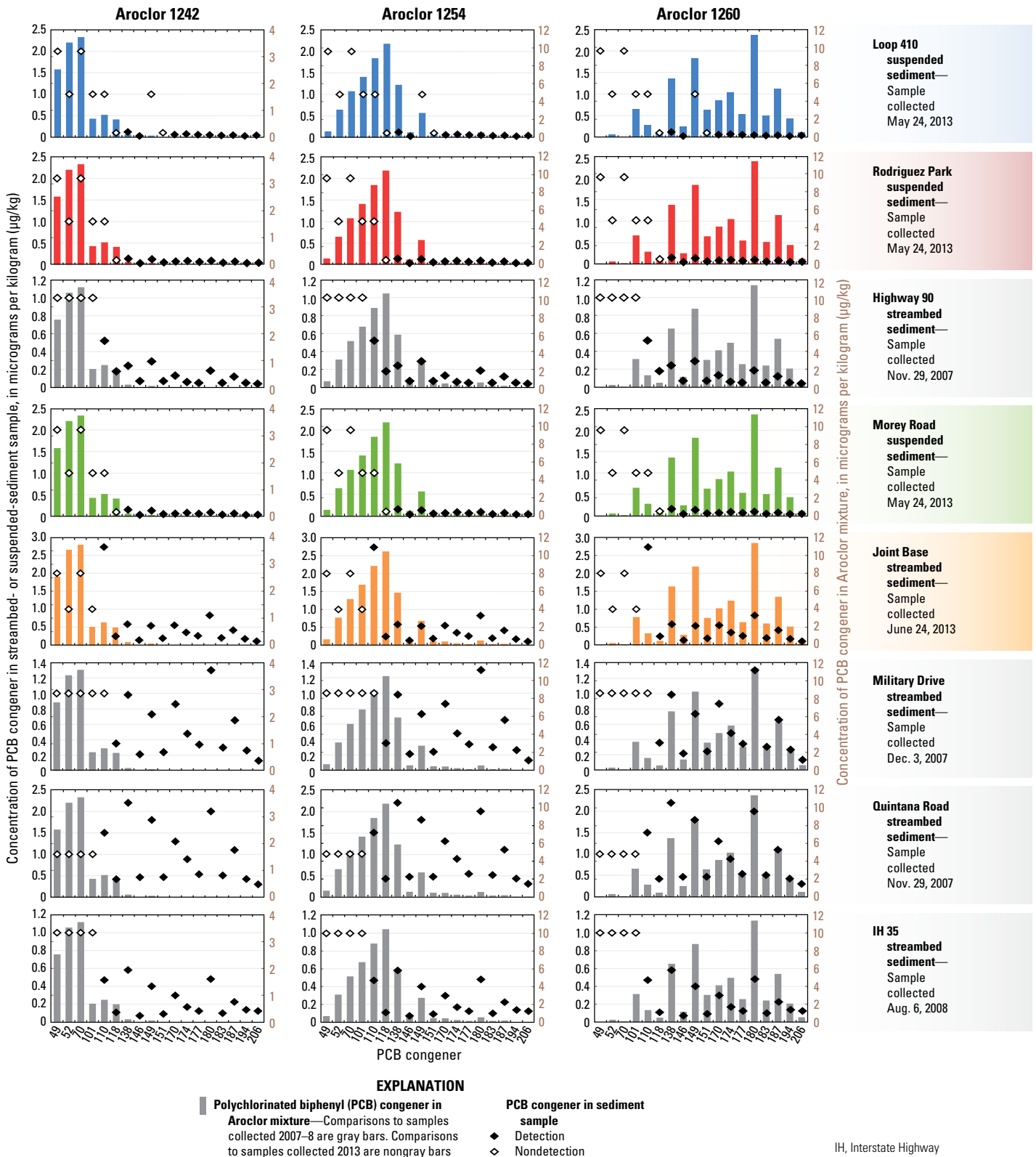

Figure 14. Comparison of polychlorinated biphenyl congeners in commercial Aroclor mixtures and selected streambed- and suspended-sediment samples collected from Leon Creek, San Antonio, Texas, 2007–8 and 2014.

are typically censored at the highest IRL when performing statistical analyses with nondetections (Helsel, 2005), which essentially eliminated detections at concentrations less than the IRL leaving insufficient data for analysis. And finally, regardless of the nondetections in the stream-sediment sample results, the sample size is small (less than 100), which prohibits the use of multivariate statistics or principal component analyses.

Summary

The U.S. Geological Survey (USGS), in cooperation with the San Antonio River Authority, collected streambed- and suspended-sediment samples from Leon Creek during 2012–14 to characterize selected contaminants in Leon Creek, San Antonio, Texas. Stream-sediment samples were collected from Leon Creek at northwest Interstate Highway 410 (USGS station 08181435 Leon Creek at Loop 410 at San Antonio, Tex.; hereinafter referred to as the “Loop 410 site”), Rodriguez Park (USGS station 292443098364600 Leon Creek at Rodriguez Park, San Antonio, Tex.; hereinafter referred to as the “Rodriguez Park site”), the northern boundary of the Joint Base San Antonio-Lackland (USGS station 292338098360501 Leon Creek at Morey Road, San Antonio, Tex.; hereinafter referred to as the “Morey Road site”), and on the southern part of the Joint Base San Antonio-Lackland (USGS 292240098353600 Leon Creek at Lackland Air Force Base Golf Course, San Antonio, Tex.; hereinafter referred to as the “Joint Base site”). The USGS periodically collected streambed-sediment samples during low flow and suspended-sediment samples during high flow. The samples were analyzed for major and trace elements and halogenated organic compounds (pesticides, flame retardants, and polychlorinated biphenyl [PCB] congeners). The degree of contamination of each sample was assessed by comparing concentrations to consensus-based sediment-quality guidelines (SQGs). The frequencies with which the halogenated organic compounds were detected in the stream-sediment samples were assessed, and comparisons of concentrations among site samples were made to describe the occurrence and distribution of the contaminants and potential sources of the PCBs.

Concentrations of the contaminants in the stream-sediment samples were compared to consensus-based SQGs to determine the degree of contamination. Two SQG concentration levels were used: (1) a lower level, called the threshold effect concentration (TEC), and (2) a higher level, called the probable effect concentration (PEC). Adverse effects to benthic biota are not expected when the concentration is less than the TEC, whereas adverse effects to benthic biota are likely when the PEC is exceeded. No trace element concentrations were greater than the PEC in any of the samples. The concentrations of copper, lead, and mercury were less than the TEC in all of the samples. The percentage of samples with concentrations greater than the TEC for all eight trace elements was greatest at the Morey

Road site (41 percent) followed by the Joint Base (27 percent), Rodriguez Park (18 percent), and Loop 410 (14 percent) sites.

Pesticides that have been banned for several decades are commonly detected in Leon Creek stream sediments, particularly the chlordane compounds. The chlordane compounds were detected in 84 percent of the samples and at every sample collection site. The samples collected from the Rodriguez Park site had the most pesticide compounds detected. None of the samples collected from the Loop 410, Rodriguez Park, or Morey Road sites had dichlorodiphenyldichloroethane (DDD), dichlorodiphenyldichloroethylene (DDE), or dichlorodiphenyltrichloroethane (DDT) concentrations greater than the TEC. Several of the samples collected from the Joint Base site had DDD, DDE, or DDT concentrations greater than the TEC, and a few were greater than the PEC. Whereas the frequent detections of pesticides in the Leon Creek stream sediments are notable, the few concentrations that exceed higher SQGs at the Joint Base site are of most concern.

Flame retardants were found at every site on Leon Creek where stream sediments were collected; however, some compounds were frequently detected in the laboratory reagent blanks so their detections in the environmental samples may not be from local sources. Dechlorane plus and polybrominated diphenyl ether (PBDE) congener 153 were the most frequently detected flame retardant compounds. The concentrations of flame retardants were greater in the suspended-sediment samples than the streambed-sediment samples and were greater than the Environment Canada SQG in many cases. Flame retardants in Leon Creek stream sediments are of moderate concern based on their frequent occurrence and concentrations in suspended sediments.

Eighteen PCB congeners were quantified in the stream-sediment samples. The samples collected from the Joint Base site had the most frequent PCB congener detections. Total PCB concentrations, computed as the sum of the 18 congeners by using the Kaplan-Meier method for left-censored environmental data, were much smaller than the TEC of 59.8 micrograms per kilograms ($\mu\text{g}/\text{kg}$). When detected, the concentrations of total PCBs in the stream-sediment samples collected from Leon Creek during 2012–14 ranged from an estimated 0.2 to 8.7 $\mu\text{g}/\text{kg}$. The results from the quality-control samples indicated negative or low bias for the PCB congener concentrations, which may have resulted in slightly lower reported concentrations than actual environmental concentrations.

This report focused primarily on PCBs because the concentrations in Leon Creek were greater than other streams in Bexar County and fish consumption advisories in Leon Creek had been linked to PCBs. Sediment samples were collected from Leon Creek by the USGS during 2007–9 and 2012–14 at eight sites following identical field and laboratory methods and were evaluated to determine if potential PCB sources could be identified. Total PCB concentrations in the sediment samples collected from the Loop 410 site

downstream to the Morey Road site were less than the PCB reporting levels or low relative to total PCB concentrations measured in samples collected from sites farther downstream. PCB congeners 180 and 138 constituted the greatest proportion of the PCB mixture in samples collected upstream from, on, and downstream from the Joint Base site. Congeners 180 and 138 constituted 50 percent and 35 percent, respectively, of the PCBs congeners found in the samples collected from the Loop 410 site, Rodriguez Park site, USGS station 08181445 Leon Creek at State Highway 90, San Antonio, Tex. (hereinafter referred to as the “Highway 90 site”), and Morey Road site. Congeners 180 and 138 constituted 80 percent and 13 percent, respectively, of the PCBs congeners found in the samples collected from the Joint Base site, USGS station 292156098350900 Leon Creek at Southwest Military Drive, San Antonio, Tex. (hereinafter referred to as the “Military Drive site”), USGS station 292029098351400 Leon Creek at Quintana Road, San Antonio, Tex. (hereinafter referred to as the “Quintana Road site”), and USGS station 08181480 Leon Creek at Interstate Highway 35, San Antonio, Tex. (hereinafter referred to as the “IH 35 site”). Differences between PCB mixtures at the Leon Creek stream-sediment sampling sites were evaluated statistically by computing the Chi-square (X^2) test statistic between the proportional PCB congener profiles of selected samples. The mean X^2 test statistic was greatest (PCB mixtures different) between the samples collected from the Loop 410 and Military Drive (0.228 ± 0.13), Loop 410 and Quintana Road (0.210 ± 0.08), and Loop 410 and Joint Base (0.205 ± 0.08). The mean X^2 test statistic was lowest (PCB mixtures similar) between the samples collected from Quintana Road and Military Drive (0.030 ± 0.03), Joint Base and Quintana Road (0.034 ± 0.04), and Highway 90 and Quintana Road (0.037 ± 0.02). The PCB congener mixtures in the stream-sediment samples collected from Leon Creek during 2007–9 and 2012–14 were compared to Aroclors 1242, 1254, and 1260 to identify similarities in the congener patterns. The PCB congener pattern in the Leon Creek stream-sediment samples is most like the congener mixture in Aroclor 1260, which is chemically similar to the PCBs detected in the fish samples that resulted in the 2003 fish consumption advisory.

References Cited

- Agency for Toxic Substances and Disease Registry, 1994, Toxicological profile for chlordane: U.S. Department of Health and Human Services, accessed August 17, 2015, at <http://www.atsdr.cdc.gov/toxprofiles/tp31.pdf>.
- Agency for Toxic Substances and Disease Registry, 2000, Toxicological profile for polychlorinated biphenyls (PCBs): U.S. Department of Health and Human Services, accessed August 10, 2015, at <http://www.atsdr.cdc.gov/ToxProfiles/tp17.pdf>.
- Agency for Toxic Substances and Disease Registry, 2015, Draft toxicological profile for polybrominated diphenyl ethers (PBDEs): U.S. Department of Health and Human Services, accessed December 15, 2015, at <http://www.atsdr.cdc.gov/toxprofiles/tp207.pdf>.
- Alamo Area Council of Governments, 2005, Closed landfill inventory: Accessed August 31, 2015, at <http://arcserver.aacog.com/flexviewers/ClosedLandFills/index.html>.
- Ballschmiter, Karlheinz, and Zell M., 1980, Analysis of polychlorinated biphenyls (PCB) by glass capillary gas chromatography—Composition of technical Aroclor and Clophen-PCB mixtures: Fresenius' Journal of Analytical Chemistry, v. 302, no. 1, p. 20–31.
- Briggs, P.H., and Meier, A.L., 2002, The determination of forty-two elements in geological materials by inductively coupled plasma-mass spectrometry for NAWQA, chapter J, in Taggart, J.E., Jr., ed., Analytical methods for chemical analysis of geologic and other materials: U.S. Geological Survey Open-File Report 02–223, p. J1–J14. [Also available at http://pubs.usgs.gov/of/2002/ofr-02-0223/J22NAWQAMethod_M.pdf.]
- Brown, Z.A., and Curry, K.J., 2002, Total carbon by combustion, chapter R, in Taggart, J.E., Jr., ed., Analytical methods for chemical analysis of geologic and other materials: U.S. Geological Survey Open-File Report 02–223, p. R1–R4. [Also available at http://pubs.usgs.gov/of/2002/ofr-02-0223/R10TotalCarbon_M.pdf.]
- Brown, Z.A., Papp, Clara, Brandt, Elaine, and Aruscavage, Phillip, 2002, Carbonate carbon by coulometric titration, chapter S, in Taggart, J.E., Jr., ed., Analytical methods for chemical analysis of geologic and other materials: U.S. Geological Survey Open-File Report 02–223, p. S1–S6. [Also available at http://pubs.usgs.gov/of/2002/ofr-02-0223/S08CarbonateCarbon_S.pdf.]
- Cacela, Dave, Beltman, D.J., and Lipton, Joshua, 2002, Polychlorinated biphenyl source attribution in Green Bay, Wisconsin, USA, using multivariate similarity among congener profiles in sediment samples: Environmental Toxicology and Chemistry, v. 21, no. 8, p. 1591–1599.
- Childress, C.J.O., Foreman, W.T., Connor, B.F., and Maloney, T.J., 1999, New reporting procedures based on long-term method detection levels and some considerations for interpretations of water-quality data provided by the U.S. Geological Survey National Water-Quality Laboratory: U.S. Geological Survey Open-File Report 99–193, 19 p.
- Chiou, C.T., Peters, L.J., and Freed, V.H., 1979, A physical concept of soil-water equilibria for nonionic compounds: Science, v. 206, p. 831–832.

- Colby, B.R., 1963, Fluvial sediments—A summary of source, transportation, deposition, and measurement of sediment discharge, *in* Contributions to general geology 1963, chapter A: U.S. Geological Survey Bulletin 1181–A, 47 p., accessed February 24, 2016, at <http://pubs.usgs.gov/bul/1181a/report.pdf>.
- Colman, J.A., 2000, Source identification and fish exposure for polychlorinated biphenyls using congener analysis from passive water samplers in the Millers River Basin, Massachusetts: U.S. Geological Survey Water-Resources Investigations Report 00–4250, 44 p.
- Eisenreich, S.J., Baker, J.E., Franz, T., Swanson, M., Rapaport, R.A., Strachan, W.M.J., and Hites, R.A., 1992, Atmospheric deposition of hydrophobic organic contaminants to the Laurentian Great Lakes, *in* Schnoor, J.L., ed., Fate of pesticides and chemicals in the environment: New York, John Wiley, p. 51–78.
- Eisenreich, S.J., Capel, P.D., and Looney, B.B., 1983, PCB dynamics in Lake Superior water, *in* Mackay, D., Paterson, S., Eisenreich, S.J., and Simmons, M., eds., Physical behavior of PCBs in the Great Lakes: Ann Arbor, Mich., Ann Arbor Science, p. 181–211.
- Environment Canada, 2013, Canadian Environmental Protection Act, 1999, Federal Environmental Quality Guidelines, Polybrominated Diphenyl Ethers (PBDEs): Environment Canada, 25 p. [Also available at http://www.ec.gc.ca/ese-ees/05DF7A37-60FF-403F-BB37-0CC697DBD9A3/FEQG_PBDE_EN.pdf.]
- Frame, G.M., Cochran, J.W., and Bowadt, S.S., 1996, Complete PCB congener distributions for 17 Aroclor mixtures determined by 3 HRGC systems optimized for comprehensive, quantitative, congener-specific analysis: *Journal of High Resolution Chromatography*, v.19, p. 657–668.
- Geboy, N.J., and Engle, M.A., 2011, Quality assurance and quality control of geochemical data—A primer for the research scientist: U.S. Geological Survey Open File Report 1181, 28 p., accessed February 25, 2016, at <http://pubs.usgs.gov/of/2011/1187/pdf/ofr2011-1187.pdf>.
- Haan, C.T., 1977, Statistical methods in hydrology: Ames, Iowa, Iowa State University Press, 378 p.
- Hageman, P.L., 2007, Determination of mercury in aqueous and geologic materials by continuous flow-cold vapor-atomic fluorescence spectrometry (CVAFS): U.S. Geological Survey Techniques and Methods, book 5, chap. D2, 6 p.
- Helsel, D.R., 2005, Nondetects and data analysis: statistics for censored environmental data: Hoboken, N.J., John Wiley, 250 p.
- Helsel, D.R., 2009, Summing nondetects—Incorporating low-level contaminants in risk assessment: *Integrated Environmental Assessment and Management*, v. 6, p. 361–366.
- Homer, C.G., Dewitz, J.A., Yang, Limin, Jin, Suming, Danielson, Patrick, Xian, George, Coulston, John, Herold, N.D., Wickham, J.D., and Megown, Kevin, 2015, Completion of the 2011 National Land Cover Database for the conterminous United States—Representing a decade of land cover change information: *Photogrammetric Engineering and Remote Sensing*, v. 81, no. 5, p. 345–354.
- Horowitz, A.J., 1991, A primer on sediment-trace element chemistry (2d ed.): U.S. Geological Survey Open-File Report 91–76, 136 p., accessed February 26, 2016, at <http://pubs.usgs.gov/of/1991/0076/report.pdf>.
- Horowitz, A.J., and Elrick, K.A., 1987, The relation of stream sediment surface area, grain size and composition to trace element chemistry: *Applied Geochemistry*, v. 2, p. 437–451.
- Horowitz, A.J., Demas, C.R., Fitzgerald, K.K., Miller, T.L., and Rickert, D.A., 1994, U.S. Geological Survey protocol for the collection and processing of surface-water samples for the subsequent determination of inorganic constituents in filtered water: U.S. Geological Survey Open-File Report 94–539, 57 p.
- Iman, R.L., and Conover, W.J., 1983, A modern approach to statistics: New York, John Wiley, 496 p.
- International Agency for Research on Cancer, 1978, IARC monographs on the evaluation of the carcinogenic risk of chemicals to humans, volume 18—Polychlorinated biphenyls and polybrominated biphenyls: Lyon, France, World Health Organization, 140 p.
- Johnson, G.W., Jarman, W.M., Bacon, C.E., Davis, J.A., Ehrlich, Robert, and Risebrough, R.W., 2000, Resolving polychlorinated biphenyl source fingerprints in suspended particulate matter of San Francisco Bay: *Environmental Science and Technology*, v. 34, no. 4, p. 552–559.
- Joint Base San Antonio, 2015, Joint Base San Antonio history, accessed October 28, 2015, at: <http://www.jbsa.mil/Information/History.aspx>.
- Jones, K.C., and de Voogt, Pim, 1999, Persistent organic pollutants (POPs)—State of the science: *Environmental Pollution*, v. 100, p. 209–221.
- Karickhoff, S.W., Brown, D.S., and Scott, T.A., 1979, Sorption of hydrophobic pollutants on natural sediments: *Water Research*, v. 13, p. 241–248.

- MacDonald, D.D., Ingersoll, C.G., and Berger, T.A., 2000, Development and evaluation of consensus-based sediment quality guidelines for freshwater ecosystems: Archives of Environmental Contamination and Toxicology, v. 39, p. 20–31.
- Mahler, B.J., and Van Metre, P.C., 2003, A simplified approach for monitoring of hydrophobic organic contaminants associated with suspended sediment: Methodology and applications: Archives of Environmental Contamination and Toxicology, v. 44, p. 288–297.
- Mahler, B.J., Van Metre, P.C., Wilson, J.T., Guilfoyle, A.L., and Sunvison, M.W., 2006, Concentrations, loads, and yields of particle-associated contaminants in urban creeks, Austin, Texas, 1999–2004: U.S. Geological Survey Scientific Investigations Report 2006–5262, 107 p., accessed March 2, 2016, at <http://pubs.usgs.gov/sir/2006/5262/>.
- Mueller, D.K., Schertz, T.L., Martin, J.D., and Sandstrom, M.W., 2015, Design, analysis, and interpretation of field quality-control data for water-sampling projects: U.S. Geological Survey Techniques and Methods book 4, chap. C4, 54 p. [Also available at <http://dx.doi.org/10.3133/tm4C4>.]
- National Institute of Standards and Technology, 2000, Report of investigation, reference material 8704, Buffalo River sediment: National Institute of Standards and Technology, Standard Reference Materials, 4 p. [Also available at https://clu-in.org/conf/tio/xrf_082808/cd/NIST-Standard-Reference-Materials/NIST_RM_8704.pdf.]
- National Institute of Standards and Technology, 2015, Certificate of analysis, standard reference material 1941b, organics in marine sediment: National Institute of Standards and Technology, Certificates, 15 p. [Also available at <https://www-s.nist.gov/srmors/certificates/1941B.pdf?CFID=22752168&CFTOKEN=43765724e34d3e39-5FDFCDC7-EAE5-C335-A3515DB619DF2E51>.]
- Noriega, M.C., Wydoski, D.S., and Foreman, W.T., 2003, Methods of analysis by the U.S. Geological Survey National Water Quality Laboratory—Determination of organochlorine pesticides and polychlorinated biphenyls in bottom and suspended sediment by gas chromatography with electron capture detection: U.S. Geological Survey Water-Resources Investigations Report 03–4293, 46 p.
- Pearson, R.F., Hornbuckle, K.C., Eisenreich, S.J., and Swackhamer, D.L., 1996, PCBs in Lake Michigan water revisited: Environmental Science and Technology, v. 30, p. 1429–1436.
- Pirkey, K.D., and Glodt, S.R., 1998, Quality control at the U.S. Geological Survey National Water Quality Laboratory: U.S. Geological Survey Fact Sheet FS–026–98, 4 p.
- Rostad, C.E., Bishop, L.M., Ellis, G.S., Leiker, T.J., Monsterleet, S.G., and Pereira, W.E., 1995, Polychlorinated biphenyls and other synthetic organic contaminants associated with sediments and fish in the Mississippi River, in Meade, R.H., ed., Contaminants in the Mississippi River, 1987–92: U.S. Geological Survey Circular 1133, p. 103–113.
- Rowe, B.L., Delzer, G.C., Bender, D.A., and Zogorski, J.S., 2005, Volatile organic compound matrix spike recoveries for ground- and surface-water samples, 1997–2001: U.S. Geological Survey Scientific Investigations Report 2005–5225, 51 p.
- Segev, Osnat, Kushmaro, Ariel, and Brenner, Asher, 2009, Environmental impact of flame retardants (persistence and biodegradability): International Journal of Environmental Research and Public Health, v. 6, no. 2, p. 478–491, accessed March 2, 2016, at <http://www.ncbi.nlm.nih.gov/pmc/articles/PMC2672362/>.
- Senesil, G.S., Baldassarre, G., Senesi, Nicola, Radina, B., 1999, Trace element inputs into soils by anthropogenic activities and implications for human health: Chemosphere, v. 39, no. 2, p. 343–377.
- Shelton, L.R., and Capel, P.D., 1994, Guidelines for collecting and processing samples of stream bed sediment for analysis of trace elements and organic contaminants for the National Water-Quality Assessment Program: U.S. Geological Survey Open File Report 94–458, 20 p.
- Sinkkonen, Seija, and Paasivirta, Jaakko, 2000, Degradation half-life times of PCDDs, PCDFs and PCBs for environmental fate modeling: Chemosphere, v. 40, p. 943–949.
- Smith, J.A., Witkowski, P.J., and Fusillo, T.V., 1988, Manmade organic compounds in the surface water of the United States—A review of current understanding: U.S. Geological Survey Circular 1007, 92 p.
- Texas Commission on Environmental Quality, 2009, Source water assessment: Accessed August 31, 2015, at: https://www.tceq.texas.gov/drinkingwater/SWAP/index_swa.html.
- Texas Commission on Environmental Quality, 2015, 2014 Guidance for assessing and reporting surface water quality in Texas, in compliance with sections 305(b) and 303(d) of the Federal Clean Water Act: Surface Water Quality Monitoring Program, Monitoring and Assessment Section, Water Quality Planning Division, accessed July 23, 2015, at https://www.tceq.texas.gov/assets/public/waterquality/swqm/assess/14txir/2014_guidance.pdf.
- Texas Department of Health, 2003, Quantitative risk characterization, lower Leon Creek, San Antonio, Bexar County, Texas: Austin, Seafood Safety Division, Environmental Epidemiology and Toxicology Division, 21 p.

- Texas Department of State Health Services, 2010, Characterization of potential adverse health effects associated with consuming fish from lower Leon Creek, Bexar County, Texas: Austin, Texas, Division for Regulatory Services; Policy, Standards, and Quality Assurance Unit; Seafood and Aquatic Life Group, 46 p.
- U.S. Census Bureau, 2015, 1 Million milestone—U.S. cities with a population of a million or more as of July 1, 2014, and the number and percentage of people added since July 1, 2013, accessed March 2, 2016, at https://www.census.gov/content/dam/Census/newsroom/releases/2015/cb15-89_graphic.jpg.
- U.S. Environmental Protection Agency, 2000, Site remediation technology InfoBase—A guide to Federal programs, information resources, and publications on contaminated site cleanup technologies, (2d ed.): Prepared by the Member Agencies of the Federal Remediation Technologies Roundtable, EPA 542-B-00-005, 83 p.
- U.S. Environmental Protection Agency, 2014, Technical Fact Sheet—Polybrominated Diphenyl Ethers (PBDEs) and Polybrominated Biphenyls (PBBs): Office of Solid Waste and Emergency Response, EPA 505-F-14-006, 7 p.
- U.S. Geological Survey, 2002, Data bases—Electronic transmission of analytical laboratory data for entry into QWDATA Release 4_1: Office of Water Quality Technical Memorandum 2002.06, accessed September 9, 2015, at <http://water.usgs.gov/admin/memo/QW/tech.qwdata.0206.htm>.
- Van Metre, P.C., and Mahler, B.J., 2014, PAH concentrations in lake sediment decline following ban on coal-tar-based pavement sealants in Austin, Texas: *Environmental Science and Technology*, v. 48, p. 7222–7228.
- Van Metre, P.C., Wilson, J.T., Callender, Edward, and Fuller, C.C., 1998, Similar rates of decrease of persistent, hydrophobic and particle-reactive contaminants in riverine systems: *Environmental Science and Technology*, v. 32, p. 3312–3317.
- Van Metre, P.C., Wilson, J.T., Harwell, G.R., Gary, M.O., Heitmuller, F.T., and Mahler, B.J., 2003, Occurrence, trends, and sources in particle-associated contaminants in selected streams and lakes in Fort Worth, Texas: U.S. Geological Survey Water-Resources Investigations Report 03-4169, 154 p.
- Wilson, J.T., 2011, Assessment of selected contaminants in streambed- and suspended-sediment samples collected in Bexar County, Texas, 2007–09: U.S. Geological Survey Scientific Investigations Report 2011-5097, 57 p. [Appendixes available online at <http://pubs.usgs.gov/sir/2011/5097/>.]

Tables 3, 6, and 8

40 Occurrence and Concentrations of Selected Trace Elements and Halogenated Organic Compounds in Stream Sediments

Table 3. Relative percent difference (RPD) of concentrations of inorganic and organic constituents in duplicate streambed- and suspended-sediment samples collected from sites on Leon Creek, San Antonio, Texas, 2012–14.

[QC, quality control; --, no data; SB, bottom material; SBQ, QC sample - bottom material; SS, suspended sediment; SSQ, QC sample - suspended sediment; <, less than; E, estimated; v, analyte detected in laboratory blank]

Station number	Station name	Site identifier (table 1)	Date	Medium code (QC sample type)	Calcium (milligrams per kilogram)	Magnesium (milligrams per kilogram)	Potassium (milligrams per kilogram)	Sodium (milligrams per kilogram)
08181435	Leon Creek at Loop 410 at San Antonio, Tex.	Loop 410	11/15/2012	SB	210,000	5,840	9,600	820
08181435	Leon Creek at Loop 410 at San Antonio, Tex.	Loop 410	11/15/2012	SBQ (replicate)	200,000	5,730	9,300	780
RPD of replicate sample concentrations:					5	2	3	5
292240098353600	Leon Creek at Lackland Air Force Base Golf Course, San Antonio, Tex.	Joint Base	11/16/2012	SB	116,000	7,290	11,300	3,340
292240098353600	Leon Creek at Lackland Air Force Base Golf Course, San Antonio, Tex.	Joint Base	11/16/2012	SBQ (replicate)	116,000	7,150	11,200	3,350
RPD of replicate sample concentrations:					0	2	1	0
08181435	Leon Creek at Loop 410 at San Antonio, Tex.	Loop 410	5/14/2013	SB	190,000	5,970	8,800	800
08181435	Leon Creek at Loop 410 at San Antonio, Tex.	Loop 410	5/14/2013	SBQ (replicate)	200,000	5,900	8,600	770
RPD of replicate sample concentrations:					5	1	2	4
08181435	Leon Creek at Loop 410 at San Antonio, Tex.	Loop 410	2/7/2013	SB	208,000	5,830	8,800	760
08181435	Leon Creek at Loop 410 at San Antonio, Tex.	Loop 410	2/7/2013	SBQ (replicate)	202,000	5,790	8,600	740
RPD of replicate sample concentrations:					3	1	2	3
292338098360501	Leon Creek at Morey Road, San Antonio, Tex.	Morey Road	2/6/2013	SB	163,000	6,290	10,000	2,150
292338098360501	Leon Creek at Morey Road, San Antonio, Tex.	Morey Road	2/6/2013	SBQ (replicate)	159,000	6,140	9,800	2,140
RPD of replicate sample concentrations:					2	2	2	0
292338098360501	Leon Creek at Morey Road, San Antonio, Tex.	Morey Road	6/25/2013	SB	158,000	6,540	10,600	2,140
292338098360501	Leon Creek at Morey Road, San Antonio, Tex.	Morey Road	6/25/2013	SBQ (replicate)	141,000	6,050	10,000	2,080
RPD of replicate sample concentrations:					11	8	6	3
08181435	Leon Creek at Loop 410 at San Antonio, Tex.	Loop 410	7/22/2014	SB	214,000	6,260	9,300	830
08181435	Leon Creek at Loop 410 at San Antonio, Tex.	Loop 410	7/22/2014	SBQ (replicate)	212,000	6,290	8,900	770
RPD of replicate sample concentrations:					1	0	4	8
292338098360501	Leon Creek at Morey Road, San Antonio, Tex.	Morey Road	5/24/2013	SS	14,700	600	1,000	4,200
292338098360501	Leon Creek at Morey Road, San Antonio, Tex.	Morey Road	5/24/2013	SSQ (replicate)	13,100	600	1,100	4,700
RPD of replicate sample concentrations:					12	0	10	11
292443098364600	Leon Creek at Rodriguez Park, San Antonio, Tex.	Rodriguez Park	4/30/2013	SS	14,800	580	1,000	700
292443098364600	Leon Creek at Rodriguez Park, San Antonio, Tex.	Rodriguez Park	4/30/2013	SSQ (replicate)	14,700	560	960	800
RPD of replicate sample concentrations:					1	4	4	13

Table 3. Relative percent difference (RPD) of concentrations of inorganic and organic constituents in duplicate streambed- and suspended-sediment samples collected from sites on Leon Creek, San Antonio, Texas, 2012–14.—Continued

[QC, quality control; --, no data; SB, bottom material; SBQ, QC sample - bottom material; SS, suspended sediment; SSQ, QC sample - suspended sediment; <, less than; E, estimated; v, analyte detected in laboratory blank]

Site identifier (table 1)	Date	Medium code (QC sample type)	Carbon (inorganic plus organic) (percent)	Inorganic carbon (percent)	Phosphorus (milligrams per kilogram)	Aluminum (milligrams per kilogram)	Barium (milligrams per kilogram)	Beryllium (milligrams per kilogram)	Bismuth (milligrams per kilogram)	Cadmium (milligrams per kilogram)
Loop 410	11/15/2012	SB	--	5.9	590	37,000	150	0.92	0.15	0.3
Loop 410	11/15/2012	SBQ	--	5.8	560	37,000	150	0.95	0.15	0.3
		(replicate)								
		RPD of replicate sample concentrations:	--	2	5	0	0	3	0	0
Joint Base	11/16/2012	SB	5.0	3.1	790	50,000	260	1.3	0.27	0.6
Joint Base	11/16/2012	SBQ	4.8	3.2	780	50,000	270	1.1	0.27	0.5
		(replicate)								
		RPD of replicate sample concentrations:	4	3	1	0	4	17	0	18
Loop 410	5/14/2013	SB	6.8	5.9	600	36,000	140	0.83	0.16	0.3
Loop 410	5/14/2013	SBQ	6.8	6.0	610	35,000	140	0.76	0.17	0.3
		(replicate)								
		RPD of replicate sample concentrations:	0	2	2	3	0	9	6	0
Loop 410	2/7/2013	SB	6.9	6.0	590	36,000	150	0.84	0.15	0.3
Loop 410	2/7/2013	SBQ	6.8	6.1	570	36,000	150	0.74	0.15	0.3
		(replicate)								
		RPD of replicate sample concentrations:	1	2	3	0	0	13	0	0
Morey Road	2/6/2013	SB	6.3	4.7	940	43,000	190	1.1	0.21	0.3
Morey Road	2/6/2013	SBQ	6.2	4.6	910	44,000	190	1.1	0.21	0.3
		(replicate)								
		RPD of replicate sample concentrations:	2	2	3	2	0	0	0	0
Morey Road	6/25/2013	SB	6.0	4.6	1,000	38,000	230	1.3	0.18	0.3
Morey Road	6/25/2013	SBQ	6.0	4.5	980	34,000	220	1.3	0.17	0.3
		(replicate)								
		RPD of replicate sample concentrations:	0	2	2	11	4	0	6	0
Loop 410	7/22/2014	SB	7.2	6.5	620	33,000	140	0.94	0.13	0.3
Loop 410	7/22/2014	SBQ	7.4	6.6	610	31,000	140	0.98	0.13	0.3
		(replicate)								
		RPD of replicate sample concentrations:	3	2	2	6	0	4	0	0
Morey Road	5/24/2013	SS	5.8	4.4	810	38,000	220	1.2	0.2	0.2
Morey Road	5/24/2013	SSQ	5.5	3.8	810	42,000	230	1.2	0.2	0.2
		(replicate)								
		RPD of replicate sample concentrations:	5	15	0	10	4	0	0	0
Rodriguez Park	4/30/2013	SS	7.5	4.5	1,020	49,000	200	1.4	0.30	0.4
Rodriguez Park	4/30/2013	SSQ	7.7	4.6	1,030	47,000	200	1.3	0.25	0.4
		(replicate)								
		RPD of replicate sample concentrations:	3	2	1	4	0	7	18	0

42 Occurrence and Concentrations of Selected Trace Elements and Halogenated Organic Compounds in Stream Sediments

Table 3. Relative percent difference (RPD) of concentrations of inorganic and organic constituents in duplicate streambed- and suspended-sediment samples collected from sites on Leon Creek, San Antonio, Texas, 2012–14.—Continued

[QC, quality control; --, no data; SB, bottom material; SBQ, QC sample - bottom material; SS, suspended sediment; SSQ, QC sample - suspended sediment; <, less than; E, estimated; v, analyte detected in laboratory blank]

Site identifier (table 1)	Date	Medium code (QC sample type)	Cesium (milligrams per kilogram)	Chromium (milligrams per kilogram)	Cobalt (milligrams per kilogram)	Copper (milligrams per kilogram)	Gallium (milligrams per kilogram)	Iron (milligrams per kilogram)	Lead (milligrams per kilogram)	Lithium (milligrams per kilogram)
Loop 410	11/15/2012	SB	5.40	42	4	11	8	14,000	9	28
Loop 410	11/15/2012	SBQ	5.40	40	4	12	8	13,000	10	27
		(replicate)								
		RPD of replicate sample concentrations:	0	5	0	9	0	7	11	4
Joint Base	11/16/2012	SB	4.80	55	6	20	11	24,000	28	27
Joint Base	11/16/2012	SBQ	4.90	58	6	20	11	24,000	28	27
		(replicate)								
		RPD of replicate sample concentrations:	2	5	0	0	0	0	0	0
Loop 410	5/14/2013	SB	5.20	38	4	11	8	14,000	10	22
Loop 410	5/14/2013	SBQ	5.10	37	4	11	8	14,000	11	21
		(replicate)								
		RPD of replicate sample concentrations:	2	3	0	0	0	0	10	5
Loop 410	2/7/2013	SB	4.80	35	4	12	8	14,000	11	19
Loop 410	2/7/2013	SBQ	4.80	34	4	12	8	14,000	11	16
		(replicate)								
		RPD of replicate sample concentrations:	0	3	0	0	0	0	0	17
Morey Road	2/6/2013	SB	4.50	43	7	15	10	22,000	17	18
Morey Road	2/6/2013	SBQ	4.50	41	7	14	9	22,000	17	17
		(replicate)								
		RPD of replicate sample concentrations:	0	5	0	7	11	0	0	6
Morey Road	6/25/2013	SB	4.90	42	9	15	10	22,000	17	26
Morey Road	6/25/2013	SBQ	4.70	41	9	15	10	22,000	16	28
		(replicate)								
		RPD of replicate sample concentrations:	4	2	0	0	0	0	6	7
Loop 410	7/22/2014	SB	5.00	42	3	12	8	12,000	15	26
Loop 410	7/22/2014	SBQ	4.80	40	3	9	7	12,000	9	28
		(replicate)								
		RPD of replicate sample concentrations:	4	5	0	29	13	0	50	7
Morey Road	5/24/2013	SS	--	38	6	15	9	17,000	19	25
Morey Road	5/24/2013	SSQ	--	39	6	16	10	18,000	19	26
		(replicate)								
		RPD of replicate sample concentrations:	--	3	0	6	11	6	0	4
Rodriguez Park	4/30/2013	SS	--	37	10	24	12	22,000	20	23
Rodriguez Park	4/30/2013	SSQ	--	34	10	16	10	21,000	21	22
		(replicate)								
		RPD of replicate sample concentrations:	--	8	0	40	18	5	5	4

Table 3. Relative percent difference (RPD) of concentrations of inorganic and organic constituents in duplicate streambed- and suspended-sediment samples collected from sites on Leon Creek, San Antonio, Texas, 2012–14.—Continued

[QC, quality control; --, no data; SB, bottom material; SBQ, QC sample - bottom material; SS, suspended sediment; SSQ, QC sample - suspended sediment; <, less than; E, estimated; v, analyte detected in laboratory blank]

Site identifier (table 1)	Date	Medium code (QC sample type)	Manganese (milligrams per kilogram)	Mercury (milligrams per kilogram)	Molybdenum (milligrams per kilogram)	Nickel (milligrams per kilogram)	Niobium (milligrams per kilogram)	Rubidium (milligrams per kilogram)	Scandium (milligrams per kilogram)
Loop 410	11/15/2012	SB	210	0.02	1.2	18	8	53.1	5
Loop 410	11/15/2012	SBQ	210	0.02	1.1	17	8	51.2	5
		(replicate)							
		RPD of replicate sample concentrations:	0	0	9	6	0	4	0
Joint Base	11/16/2012	SB	310	0.03	0.7	20	10	65.4	7
Joint Base	11/16/2012	SBQ	310	0.05	0.7	19	10	65.3	7
		(replicate)							
		RPD of replicate sample concentrations:	0	50	0	5	0	0	0
Loop 410	5/14/2013	SB	250	0.01	1.1	7	7	50.7	5
Loop 410	5/14/2013	SBQ	260	0.01	1.0	5	7	49.6	5
		(replicate)							
		RPD of replicate sample concentrations:	4	0	10	33	0	2	0
Loop 410	2/7/2013	SB	250	0.01	1.0	5	7	48.4	5
Loop 410	2/7/2013	SBQ	250	0.01	1.0	5	7	47.1	5
		(replicate)							
		RPD of replicate sample concentrations:	0	0	0	0	0	3	0
Morey Road	2/6/2013	SB	1,280	0.02	0.7	12	7	57.2	6
Morey Road	2/6/2013	SBQ	1,250	0.02	0.7	12	7	56.5	6
		(replicate)							
		RPD of replicate sample concentrations:	2	0	0	0	0	1	0
Morey Road	6/25/2013	SB	1,590	0.01	0.7	13	7	63.1	7
Morey Road	6/25/2013	SBQ	1,740	0.01	0.7	13	6	59.4	6
		(replicate)							
		RPD of replicate sample concentrations:	9	0	0	0	15	6	15
Loop 410	7/22/2014	SB	200	0.01	1.2	7	6	47.0	5
Loop 410	7/22/2014	SBQ	190	0.01	1.2	5	6	46.0	4
		(replicate)							
		RPD of replicate sample concentrations:	5	0	0	33	0	2	22
Morey Road	5/24/2013	SS	360	0.01	0.7	10	7	--	6
Morey Road	5/24/2013	SSQ	340	0.02	0.7	11	7	--	6
		(replicate)							
		RPD of replicate sample concentrations:	6	67	0	10	0	--	0
Rodriguez Park	4/30/2013	SS	1,080	0.03	1.2	17	9	--	7
Rodriguez Park	4/30/2013	SSQ	1,350	0.04	0.8	17	8	--	7
		(replicate)							
		RPD of replicate sample concentrations:	22	29	40	0	12	--	0

44 Occurrence and Concentrations of Selected Trace Elements and Halogenated Organic Compounds in Stream Sediments

Table 3. Relative percent difference (RPD) of concentrations of inorganic and organic constituents in duplicate streambed- and suspended-sediment samples collected from sites on Leon Creek, San Antonio, Texas, 2012–14.—Continued

[QC, quality control; --, no data; SB, bottom material; SBQ, QC sample - bottom material; SS, suspended sediment; SSQ, QC sample - suspended sediment; <, less than; E, estimated; v, analyte detected in laboratory blank]

Site identifier (table 1)	Date	Medium code (QC sample type)	Silver (milligrams per kilogram)	Strontium (milligrams per kilogram)	Thallium (milligrams per kilogram)	Titanium (milligrams per kilogram)	Vanadium (milligrams per kilogram)	Zinc (milligrams per kilogram)	Antimony (milligrams per kilogram)	Arsenic (milligrams per kilogram)
Loop 410	11/15/2012	SB	0.1	380	0.39	1,900	60	61	0.7	5.3
Loop 410	11/15/2012	SBQ	0.1	370	0.35	1,780	57	57	0.7	5.2
		(replicate)								
		RPD of replicate sample concentrations:	0	3	11	7	5	7	0	2
Joint Base	11/16/2012	SB	0.3	150	0.44	2,600	77	99	0.9	6.2
Joint Base	11/16/2012	SBQ	0.3	150	0.45	2,600	76	98	0.9	6.1
		(replicate)								
		RPD of replicate sample concentrations:	0	0	2	0	1	1	0	2
Loop 410	5/14/2013	SB	0.2	330	0.36	1,700	56	58	0.7	5.4
Loop 410	5/14/2013	SBQ	0.2	340	0.36	1,700	56	58	0.6	5.8
		(replicate)								
		RPD of replicate sample concentrations:	0	3	0	0	0	0	15	7
Loop 410	2/7/2013	SB	0.2	310	0.34	1,700	53	58	0.6	5.0
Loop 410	2/7/2013	SBQ	0.2	320	0.36	1,600	52	55	0.6	4.8
		(replicate)								
		RPD of replicate sample concentrations:	0	3	6	6	2	5	0	4
Morey Road	2/6/2013	SB	0.2	160	0.45	2,000	63	73	0.6	7.4
Morey Road	2/6/2013	SBQ	0.2	160	0.43	2,000	61	71	0.6	7.3
		(replicate)								
		RPD of replicate sample concentrations:	0	0	5	0	3	3	0	1
Morey Road	6/25/2013	SB	0.1	170	0.44	2,000	66	81	0.6	12.1
Morey Road	6/25/2013	SBQ	0.1	160	0.45	1,700	61	79	0.5	12.9
		(replicate)								
		RPD of replicate sample concentrations:	0	6	2	16	8	3	18	6
Loop 410	7/22/2014	SB	<0.02	430	0.31	1,600	61	155	0.6	5.2
Loop 410	7/22/2014	SBQ	<0.02	440	0.32	1,600	58	56	0.5	5.2
		(replicate)								
		RPD of replicate sample concentrations:	--	2	3	0	5	94	18	0
Morey Road	5/24/2013	SS	<0.01	180	0.40	201	61	72	0.7	6.4
Morey Road	5/24/2013	SSQ	<0.01	180	0.42	215	66	72	0.6	6.5
		(replicate)								
		RPD of replicate sample concentrations:	--	0	5	7	8	0	15	2
Rodriguez Park	4/30/2013	SS	<1	180	0.5	190	54	92	1.0	11
Rodriguez Park	4/30/2013	SSQ	<1	180	0.5	180	52	81	1.0	10
		(replicate)								
		RPD of replicate sample concentrations:	--	0	0	5	4	13	0	10

Table 3. Relative percent difference (RPD) of concentrations of inorganic and organic constituents in duplicate streambed- and suspended-sediment samples collected from sites on Leon Creek, San Antonio, Texas, 2012–14.—Continued

[QC, quality control; --, no data; SB, bottom material; SBQ, QC sample - bottom material; SS, suspended sediment; SSQ, QC sample - suspended sediment; <, less than; E, estimated; v, analyte detected in laboratory blank]

Site identifier (table 1)	Date	Medium code (QC sample type)	alpha-Endosulfan (micrograms per kilogram)	Benfluralin (micrograms per kilogram)	beta-Endosulfan (micrograms per kilogram)	Chlorpyrifos (micrograms per kilogram)	cis-Chlordane (micrograms per kilogram)	cis-Nonachlor (micrograms per kilogram)
Loop 410	11/15/2012	SB	<0.20	<0.20	<0.20	<0.20	<0.20	<0.10
Loop 410	11/15/2012	SBQ (replicate)	<0.20	<0.20	<0.20	<0.20	<0.20	<0.10
		RPD of replicate sample concentrations:	--	--	--	--	--	--
Joint Base	11/16/2012	SB	<0.20	<0.20	<0.20	<0.20	1.18	0.37
Joint Base	11/16/2012	SBQ (replicate)	<0.20	<0.20	<0.20	<0.20	0.57	0.17
		RPD of replicate sample concentrations:	--	--	--	--	70	74
Loop 410	5/14/2013	SB	<0.20	<0.20	<0.20	<0.20	0.06	<0.10
Loop 410	5/14/2013	SBQ (replicate)	<0.20	<0.20	<0.20	<0.20	E0.08	E0.04
		RPD of replicate sample concentrations:	--	--	--	--	29	--
Loop 410	2/7/2013	SB	<0.20	<0.20	<0.20	<0.20	<0.20	<0.10
Loop 410	2/7/2013	SBQ (replicate)	<0.20	<0.20	<0.20	<0.20	0.01	<0.10
		RPD of replicate sample concentrations:	--	--	--	--	--	--
Morey Road	2/6/2013	SB	<0.20	<0.20	<0.20	<0.20	0.03	0.01
Morey Road	2/6/2013	SBQ (replicate)	<0.20	<0.20	<0.20	<0.20	0.05	E0.02
		RPD of replicate sample concentrations:	--	--	--	--	46	67
Morey Road	6/25/2013	SB	<0.20	<0.20	<0.20	<0.20	0.27	E0.21
Morey Road	6/25/2013	SBQ (replicate)	<0.20	<0.20	<0.20	<0.20	0.08	E0.04
		RPD of replicate sample concentrations:	--	--	--	--	109	136
Loop 410	7/22/2014	SB	<0.20	<0.20	<0.20	<0.20	<0.2	<0.10
Loop 410	7/22/2014	SBQ (replicate)	<0.20	<0.20	<0.20	<0.20	<0.2	<0.10
		RPD of replicate sample concentrations:	--	--	--	--	--	--
Morey Road	5/24/2013	SS	<0.20	<0.20	<0.20	E2.25	E0.69	E0.30
Morey Road	5/24/2013	SSQ (replicate)	<0.20	<0.20	<0.20	E1.30	0.75	E0.30
		RPD of replicate sample concentrations:	--	--	--	54	8	0
Rodriguez Park	4/30/2013	SS	<0.20	<0.20	<0.20	<0.20	0.44	E0.09
Rodriguez Park	4/30/2013	SSQ (replicate)	<0.20	<0.20	<0.20	<0.20	0.60	E0.12
		RPD of replicate sample concentrations:	--	--	--	--	31	29

Table 3. Relative percent difference (RPD) of concentrations of inorganic and organic constituents in duplicate streambed- and suspended-sediment samples collected from sites on Leon Creek, San Antonio, Texas, 2012–14.—Continued

[QC, quality control; --, no data; SB, bottom material; SBQ, QC sample - bottom material; SS, suspended sediment; SSQ, QC sample - suspended sediment; <, less than; E, estimated; v, analyte detected in laboratory blank]

Site identifier (table 1)	Date	Medium code (QC sample type)	Cyfluthrin (micro-grams per kilogram)	DCPA (Dacthal) (micro-grams per kilogram)	Desulfinyl-fipronil (micro-grams per kilogram)	Dieldrin (micro-grams per kilogram)	Endosulfan sulfate (micro-grams per kilogram)	Fipronil sulfide (micro-grams per kilogram)	Fipronil (micro-grams per kilogram)	Hexachlorobenzene (micro-grams per kilogram)
Loop 410	11/15/2012	SB	<0.20	<0.2	0.1	<0.10	<0.4	<0.10	--	<0.10
Loop 410	11/15/2012	SBQ	<0.20	<0.2	<0.10	<0.10	<0.4	<0.10	--	<0.10
		(replicate)								
		RPD of replicate sample concentrations:	--	--	--	--	--	--	--	--
Joint Base	11/16/2012	SB	<0.60	<0.2	0.11	0.13	<0.4	<0.10	--	<0.10
Joint Base	11/16/2012	SBQ	<0.20	<0.2	<0.10	<0.10	<0.4	<0.10	--	<0.10
		(replicate)								
		RPD of replicate sample concentrations:	--	--	--	--	--	--	--	--
Loop 410	5/14/2013	SB	E0.07	<0.2	E0.02	<0.10	<0.4	E0.02	--	<0.10
Loop 410	5/14/2013	SBQ	E2.93	<0.2	E0.95	<0.10	<0.4	E0.05	--	<0.10
		(replicate)								
		RPD of replicate sample concentrations:	191	--	192	--	--	86	--	--
Loop 410	2/7/2013	SB	<0.20	<0.2	E0.01	<0.10	<0.4	<0.10	--	<0.10
Loop 410	2/7/2013	SBQ	<0.20	<0.2	<0.10	<0.10	<0.4	<0.10	--	<0.10
		(replicate)								
		RPD of replicate sample concentrations:	--	--	--	--	--	--	--	--
Morey Road	2/6/2013	SB	<0.20	<0.2	<0.10	<0.10	<0.4	<0.10	--	<0.10
Morey Road	2/6/2013	SBQ	<0.20	<0.2	<0.10	<0.10	<0.4	<0.10	--	<0.10
		(replicate)								
		RPD of replicate sample concentrations:	--	--	--	--	--	--	--	--
Morey Road	6/25/2013	SB	E2.00	<0.2	<0.10	E0.01	<0.4	E0.01	--	<0.10
Morey Road	6/25/2013	SBQ	<2.00	<0.2	E0.07	E0.01	<0.4	E0.01	--	<0.10
		(replicate)								
		RPD of replicate sample concentrations:	--	--	--	0	--	0	--	--
Loop 410	7/22/2014	SB	<0.20	<0.2	<0.10	<0.10	<0.4	<0.10	<0.10	<0.10
Loop 410	7/22/2014	SBQ	<0.20	<0.2	<0.10	<0.10	<0.4	<0.10	<0.10	<0.10
		(replicate)								
		RPD of replicate sample concentrations:	--	--	--	--	--	--	--	--
Morey Road	5/24/2013	SS	E12.7	<0.2	<0.34	E0.28	<0.4	<0.10	--	<0.10
Morey Road	5/24/2013	SSQ	E11.9	<0.2	E0.62	E0.46	<0.4	E0.14	E6.89	<0.10
		(replicate)								
		RPD of replicate sample concentrations:	7	--	--	49	--	--	--	--
Rodriguez Park	4/30/2013	SS	E13.4	<0.2	E0.08	<0.10	<0.4	E0.05	--	<0.10
Rodriguez Park	4/30/2013	SSQ	E11.9	<0.2	E0.07	<0.10	<0.4	E0.04	--	<0.10
		(replicate)								
		RPD of replicate sample concentrations:	12	--	13	--	--	22	--	--

48 Occurrence and Concentrations of Selected Trace Elements and Halogenated Organic Compounds in Stream Sediments

Table 3. Relative percent difference (RPD) of concentrations of inorganic and organic constituents in duplicate streambed- and suspended-sediment samples collected from sites on Leon Creek, San Antonio, Texas, 2012–14.—Continued

[QC, quality control; --, no data; SB, bottom material; SBQ, QC sample - bottom material; SS, suspended sediment; SSQ, QC sample - suspended sediment; <, less than; E, estimated; v, analyte detected in laboratory blank]

Site identifier (table 1)	Date	Medium code (QC sample type)	Tefluthrin (micrograms per kilogram)	Tetra-difon (micrograms per kilogram)	trans-Chlordane (micrograms per kilogram)	trans-Non-achlor (micrograms per kilogram)	Trifluralin (micrograms per kilogram)	PCB congener 101 (micrograms per kilogram)	PCB congener 110 (micrograms per kilogram)	PCB congener 118 (micrograms per kilogram)	PCB congener 138 (micrograms per kilogram)
Loop 410	11/15/2012	SB	<0.50	<0.20	<0.20	<0.10	<0.20	<1.0	<1.0	<0.10	<0.10
Loop 410	11/15/2012	SBQ	<0.50	<0.20	<0.20	<0.10	<0.20	<1.0	<1.0	<0.10	<0.10
		(replicate)									
		RPD of replicate sample concentrations:	--	--	--	--	--	--	--	--	--
Joint Base	11/16/2012	SB	<0.50	<0.20	0.76	0.86	<0.20	<1.0	<1.0	E0.18	<0.10
Joint Base	11/16/2012	SBQ	<0.50	<0.20	0.38	0.41	<0.20	<1.0	<1.0	<0.10	<0.10
		(replicate)									
		RPD of replicate sample concentrations:	--	--	67	71	--	--	--	--	--
Loop 410	5/14/2013	SB	<0.50	<0.20	<0.20	E0.004	<0.20	<1.0	<1.0	<0.10	<0.10
Loop 410	5/14/2013	SBQ	<0.50	<0.20	E0.03	E0.11	<0.20	<1.0	<1.0	<0.10	<0.10
		(replicate)									
		RPD of replicate sample concentrations:	--	--	--	186	--	--	--	--	--
Loop 410	2/7/2013	SB	<0.50	<0.20	<0.20	<0.10	<0.20	<1.0	<1.0	<0.10	<0.10
Loop 410	2/7/2013	SBQ	<0.50	<0.20	<0.20	<0.10	<0.20	<1.0	<1.0	<0.10	<0.10
		(replicate)									
		RPD of replicate sample concentrations:	--	--	--	--	--	--	--	--	--
Morey Road	2/6/2013	SB	<0.50	<0.20	0.02	0.02	<0.20	<1.0	<1.0	<0.10	<0.10
Morey Road	2/6/2013	SBQ	<0.50	<0.20	E0.04	E0.05	<0.20	<1.0	<1.0	<0.10	<0.10
		(replicate)									
		RPD of replicate sample concentrations:	--	--	67	86	--	--	--	--	--
Morey Road	6/25/2013	SB	<0.50	--	0.18	E0.34	<0.20	<1.0	<1.0	<0.10	E0.0278
Morey Road	6/25/2013	SBQ	<0.50	<0.20	0.05	E0.09	<0.20	<1.0	<1.0	<0.10	<0.10
		(replicate)									
		RPD of replicate sample concentrations:	--	--	113	116	--	--	--	--	--
Loop 410	7/22/2014	SB	E0.04	<0.20	E0.10	E0.10	<0.20	<1.0	<1.0	<0.10	<0.10
Loop 410	7/22/2014	SBQ	<0.50	<0.20	<0.20	<0.10	<0.20	<1.0	<1.0	<0.10	<0.10
		(replicate)									
		RPD of replicate sample concentrations:	--	--	--	--	--	--	--	--	--
Morey Road	5/24/2013	SS	<0.50	--	E0.46	E0.71	<0.20	<1.0	<1.0	<0.10	0.15
Morey Road	5/24/2013	SSQ	<0.50	<0.20	0.47	E0.70	<0.20	E0.12	E0.7	<0.10	E0.17
		(replicate)									
		RPD of replicate sample concentrations:	--	--	2	1	--	--	--	--	13
Rodriguez Park	4/30/2013	SS	<0.50	<0.20	E0.39	E0.36	<0.20	<1.0	<1.0	<0.10	<0.10
Rodriguez Park	4/30/2013	SSQ	<0.50	<0.20	E0.53	E0.53	<0.20	<1.0	<1.0	<0.10	<0.10
		(replicate)									
		RPD of replicate sample concentrations:	--	--	30	38	--	--	--	--	--

Table 3. Relative percent difference (RPD) of concentrations of inorganic and organic constituents in duplicate streambed- and suspended-sediment samples collected from sites on Leon Creek, San Antonio, Texas, 2012–14.—Continued

[QC, quality control; --, no data; SB, bottom material; SBQ, QC sample - bottom material; SS, suspended sediment; SSQ, QC sample - suspended sediment; <, less than; E, estimated; v, analyte detected in laboratory blank]

Site identifier (table 1)	Date	Medium code (QC sample type)	PCB	PCB	PCB	PCB	PCB	PCB	PCB	PCB	PCB
			congener 146 (micro-grams per kilo-gram)	congener 149 (micro-grams per kilo-gram)	congener 151 (micro-grams per kilo-gram)	congener 170 (micro-grams per kilo-gram)	congener 174 (micro-grams per kilo-gram)	congener 177 (micro-grams per kilo-gram)	congener 180 (micro-grams per kilo-gram)	congener 183 (micro-grams per kilo-gram)	congener 187 (micro-grams per kilo-gram)
Loop 410	11/15/2012	SB	<0.10	<1.0	<0.10	<0.10	<0.10	<0.10	<0.10	<0.10	<0.10
Loop 410	11/15/2012	SBQ	<0.10	<1.0	<0.10	<0.10	<0.10	<0.10	<0.10	<0.10	<0.10
		(replicate)									
		RPD of replicate sample concentrations:	--	--	--	--	--	--	--	--	--
Joint Base	11/16/2012	SB	<0.10	<1.0	E0.14	E0.62	<0.10	<0.10	E0.96	E0.18	E0.41
Joint Base	11/16/2012	SBQ	<0.10	<1.0	<0.10	E0.30	<0.10	<0.10	E0.44	<0.10	E0.19
		(replicate)									
		RPD of replicate sample concentrations:	--	--	--	70	--	--	74	--	73
Loop 410	5/14/2013	SB	<0.10	<1.0	<0.10	<0.10	<0.10	<0.10	<0.10	<0.10	<0.10
Loop 410	5/14/2013	SBQ	<0.10	<1.0	<0.10	0.03	<0.10	<0.10	0.02	<0.10	<0.10
		(replicate)									
		RPD of replicate sample concentrations:	--	--	--	--	--	--	--	--	--
Loop 410	2/7/2013	SB	<0.10	<1.0	<0.10	<0.10	<0.10	<0.10	<0.10	<0.10	<0.10
Loop 410	2/7/2013	SBQ	<0.10	<1.0	<0.10	<0.10	<0.10	<0.10	<0.10	<0.10	<0.10
		(replicate)									
		RPD of replicate sample concentrations:	--	--	--	--	--	--	--	--	--
Morey Road	2/6/2013	SB	<0.10	<1.0	<0.10	<0.10	<0.10	<0.10	0.01	<0.10	<0.10
Morey Road	2/6/2013	SBQ	<0.10	<1.0	<0.10	0.02	<0.10	<0.10	0.02	<0.10	0.01
		(replicate)									
		RPD of replicate sample concentrations:	--	--	--	--	--	--	67	--	--
Morey Road	6/25/2013	SB	0.01	<1.0	<0.10	0.01	<0.10	0.01	0.01	0.01	0.01
Morey Road	6/25/2013	SBQ	0.01	<1.0	<0.10	0.01	0.02	0.01	0.02	0.01	0.01
		(replicate)									
		RPD of replicate sample concentrations:	0	--	--	0	--	0	67	0	0
Loop 410	7/22/2014	SB	<0.10	<1.0	<0.10	<0.10	<0.10	<0.10	<0.10	<0.10	<0.10
Loop 410	7/22/2014	SBQ	<0.10	<1.0	<0.10	<0.10	<0.10	<0.10	<0.10	<0.10	<0.10
		(replicate)									
		RPD of replicate sample concentrations:	--	--	--	--	--	--	--	--	--
Morey Road	5/24/2013	SS	0.04	0.1	0.05	0.06	0.08	0.06	0.09	0.04	0.07
Morey Road	5/24/2013	SSQ	0.03	E0.1	0.05	0.07	0.08	0.06	0.08	0.05	0.06
		(replicate)									
		RPD of replicate sample concentrations:	3	0	0	15	0	0	12	22	15
Rodriguez Park	4/30/2013	SS	<0.10	<1.0	<0.10	<0.10	<0.10	<0.10	0.08	<0.10	<0.10
Rodriguez Park	4/30/2013	SSQ	<0.10	<1.0	<0.10	<0.10	<0.10	<0.10	0.08	<0.10	<0.10
		(replicate)									
		RPD of replicate sample concentrations:	--	--	--	--	--	--	0	--	--

50 Occurrence and Concentrations of Selected Trace Elements and Halogenated Organic Compounds in Stream Sediments

Table 3. Relative percent difference (RPD) of concentrations of inorganic and organic constituents in duplicate streambed- and suspended-sediment samples collected from sites on Leon Creek, San Antonio, Texas, 2012–14.—Continued

[QC, quality control; --, no data; SB, bottom material; SBQ, QC sample - bottom material; SS, suspended sediment; SSQ, QC sample - suspended sediment; <, less than; E, estimated; v, analyte detected in laboratory blank]

Site identifier (table 1)	Date	Medium code (QC sample type)	PCB congener 194 (micrograms per kilogram)	PCB congener 206 (micrograms per kilogram)	PCB congener 49 (micrograms per kilogram)	PCB congener 52 (micrograms per kilogram)	PCB congener 70 (micrograms per kilogram)	1,2-Bis(2,4,6-tribromophenoxy) ethane (micrograms per kilogram)	PBDE congener 100 (micrograms per kilogram)	PBDE congener 138 (micrograms per kilogram)	PBDE congener 153 (micrograms per kilogram)
Loop 410	11/15/2012	SB	<0.10	<0.10	<2.0	<1.0	<2.0	<0.10	<0.10	<0.10	<0.10
Loop 410	11/15/2012	SBQ	<0.10	<0.10	<2.0	<1.0	<2.0	<0.10	<0.10	<0.10	<0.10
		(replicate)									
		RPD of replicate sample concentrations:	--	--	--	--	--	--	--	--	--
Joint Base	11/16/2012	SB	<0.10	<0.10	<2.0	<1.0	<2.0	<0.10	<0.20	<0.10	<0.10
Joint Base	11/16/2012	SBQ	<0.10	<0.10	<2.0	<1.0	<2.0	<0.10	<0.10	<0.10	<0.10
		(replicate)									
		RPD of replicate sample concentrations:	--	--	--	--	--	--	--	--	--
Loop 410	5/14/2013	SB	<0.10	<0.10	<2.0	<1.0	<2.0	E0.22	E0.09	<0.10	E0.06
Loop 410	5/14/2013	SBQ	<0.10	<0.10	<2.0	<1.0	<2.0	E0.094	<0.20	<0.10	E0.07
		(replicate)									
		RPD of replicate sample concentrations:	--	--	--	--	--	80	--	--	15
Loop 410	2/7/2013	SB	<0.10	<0.10	<2.0	<1.0	<2.0	<0.10	<0.10	<0.10	0.05
Loop 410	2/7/2013	SBQ	<0.10	<0.10	<2.0	<1.0	<2.0	E0.15	E0.08	<0.10	E0.08
		(replicate)									
		RPD of replicate sample concentrations:	--	--	--	--	--	--	--	--	46
Morey Road	2/6/2013	SB	<0.10	<0.10	<2.0	<1.0	<2.0	<0.10	<0.10	<0.10	<0.10
Morey Road	2/6/2013	SBQ	0.01	0.01	<2.0	<1.0	<2.0	E0.05	E0.08	<0.10	E0.05
		(replicate)									
		RPD of replicate sample concentrations:	--	--	--	--	--	--	--	--	--
Morey Road	6/25/2013	SB	0.01	0.01	<2.0	<1.0	<2.0	<0.10	<0.10	<0.10	E0.03
Morey Road	6/25/2013	SBQ	0.01	0.01	<2.0	<1.0	<2.0	<0.10	<0.10	<0.10	E0.03
		(replicate)									
		RPD of replicate sample concentrations:	0	0	--	--	--	--	--	--	0
Loop 410	7/22/2014	SB	<0.10	<0.10	<2.0	<1.0	<2.0	<0.10	0.13	<0.10	<0.10
Loop 410	7/22/2014	SBQ	<0.10	<0.10	<2.0	<1.0	<2.0	<0.10	<0.10	<0.10	<0.10
		(replicate)									
		RPD of replicate sample concentrations:	--	--	--	--	--	--	--	--	--
Morey Road	5/24/2013	SS	0.04	0.04	<2.0	<1.0	<2.0	E2.10	E0.37	<0.10	E0.25
Morey Road	5/24/2013	SSQ	0.03	0.04	<2.0	<1.0	<2.0	<0.20	E0.52	<0.10	E0.38
		(replicate)									
		RPD of replicate sample concentrations:	29	0	--	--	--	--	34	--	41
Rodriguez Park	4/30/2013	SS	0.06	<0.10	<2.0	<1.0	<2.0	E0.74	E0.49	<0.10	E0.56
Rodriguez Park	4/30/2013	SSQ	0.05	<0.10	<2.0	<1.0	<2.0	E0.43	E0.43	<0.10	E0.51
		(replicate)									
		RPD of replicate sample concentrations:	18	--	--	--	--	53	13	--	9

Table 3. Relative percent difference (RPD) of concentrations of inorganic and organic constituents in duplicate streambed- and suspended-sediment samples collected from sites on Leon Creek, San Antonio, Texas, 2012–14.—Continued

[QC, quality control; --, no data; SB, bottom material; SBQ, QC sample - bottom material; SS, suspended sediment; SSQ, QC sample - suspended sediment; <, less than; E, estimated; v, analyte detected in laboratory blank]

Site identifier (table 1)	Date	Medium code (QC sample type)	PBDE congener 154 (micrograms per kilogram)	PBDE congener 183 (micrograms per kilogram)	PBDE congener 47 (micrograms per kilogram)	PBDE congener 66 (micrograms per kilogram)	PBDE congener 71 (micrograms per kilogram)	PBDE congener 85 (micrograms per kilogram)	PBDE congener 99 (micrograms per kilogram)	Bis(hexachloro-cyclopentadieno) cyclooctane (micrograms per kilogram)	Methyl triclosan (micrograms per kilogram)
Loop 410	11/15/2012	SB	<0.10	<0.10	<0.90	<0.10	<0.10	<0.10	<0.40	<1.0	<6.0
Loop 410	11/15/2012	SBQ	<0.10	<0.10	<0.90	<0.10	<0.10	<0.10	<0.30	<1.0	<6.0
		(replicate)									
		RPD of replicate sample concentrations:	--	--	--	--	--	--	--	--	--
Joint Base	11/16/2012	SB	<0.10	<0.10	<1.00	<0.10	<0.10	<0.10	<0.70	0.7	<6.0
Joint Base	11/16/2012	SBQ	<0.10	<0.10	<1.00	<0.10	<0.10	<0.10	<0.50	<1.0	<6.0
		(replicate)									
		RPD of replicate sample concentrations:	--	--	--	--	--	--	--	--	--
Loop 410	5/14/2013	SB	E0.03	<0.10	E0.64	<0.10	<0.10	E0.0065	E0.46	E0.4	<6.0
Loop 410	5/14/2013	SBQ	E0.04	<0.50	<0.80	<0.10	<0.10	<0.10	<0.60	E0.1	<6.0
		(replicate)									
		RPD of replicate sample concentrations:	29	--	--	--	--	--	--	120	--
Loop 410	2/7/2013	SB	0.02	<0.10	<0.70	<0.10	<0.10	<0.10	<0.40	<1.0	<6.0
Loop 410	2/7/2013	SBQ	E0.04	<0.10	E0.57	<0.10	<0.10	E0.013	E0.53	<1.0	<6.0
		(replicate)									
		RPD of replicate sample concentrations:	67	--	--	--	--	--	--	--	--
Morey Road	2/6/2013	SB	<0.10	<0.10	<0.20	<0.10	<0.10	<0.10	<0.20	0.1	<6.0
Morey Road	2/6/2013	SBQ	E0.03	<0.10	<0.40	E0.01	<0.10	<0.10	E0.29	E0.6	<6.0
		(replicate)									
		RPD of replicate sample concentrations:	--	--	--	--	--	--	--	143	--
Morey Road	6/25/2013	SB	<0.10	<0.50	<0.20	<0.10	<0.10	<0.10	<0.20	E0.3	<6.0
Morey Road	6/25/2013	SBQ	E0.25	<0.50	<0.20	<0.10	<0.10	<0.10	<0.20	E0.3	<6.0
		(replicate)									
		RPD of replicate sample concentrations:	--	--	--	--	--	--	--	0	--
Loop 410	7/22/2014	SB	<0.10	<0.10	<0.50	<0.10	<0.10	<0.10	E0.43	<1.0	<6.0
Loop 410	7/22/2014	SBQ	<0.10	<0.10	<0.40	<0.10	<0.10	<0.10	0.38	<1.0	<6.0
		(replicate)									
		RPD of replicate sample concentrations:	--	--	--	--	--	--	12	--	--
Morey Road	5/24/2013	SS	E0.18	<0.50	<1.00	E0.01	<0.10	<0.10	E1.5	E0.2	<6.0
Morey Road	5/24/2013	SSQ	E0.27	<0.50	<2.00	0.02	<0.10	<0.20	1.83	<1.0	<6.0
		(replicate)									
		RPD of replicate sample concentrations:	40	--	--	67	--	--	20	--	--
Rodriguez Park	4/30/2013	SS	E0.35	<0.10	E2.35	E0.03	<0.10	E0.20	E2.59	E0.3	<6.0
Rodriguez Park	4/30/2013	SSQ	E0.30	<0.10	E2.02v	E0.02	<0.10	E0.15	E2.22v	E0.4	<6.0
		(replicate)									
		RPD of replicate sample concentrations:	15	--	15	40	--	29	15	29	--

52 Occurrence and Concentrations of Selected Trace Elements and Halogenated Organic Compounds in Stream Sediments

Table 3. Relative percent difference (RPD) of concentrations of inorganic and organic constituents in duplicate streambed- and suspended-sediment samples collected from sites on Leon Creek, San Antonio, Texas, 2012–14.—Continued

[QC, quality control; --, no data; SB, bottom material; SBQ, QC sample - bottom material; SS, suspended sediment; SSQ, QC sample - suspended sediment; <, less than; E, estimated; v, analyte detected in laboratory blank]

Site identifier (table 1)	Date	Medium code (QC sample type)	Octachloro-styrene (micrograms per kilogram)	Pentabromo-toluene (micrograms per kilogram)	Triclosan (micrograms per kilogram)	Organic carbon (percent)	Thorium (milligrams per kilogram)	Uranium (milligrams per kilogram)
Loop 410	11/15/2012	SB	<1.0	<1.0	--	0.60	5.7	2.3
Loop 410	11/15/2012	SBQ	<1.0	<1.0	--	0.23	5.7	2.3
		(replicate)						
		RPD of replicate sample concentrations:	--	--	--	89	0	0
Joint Base	11/16/2012	SB	<1.0	<1.0	--	1.88	7.7	1.9
Joint Base	11/16/2012	SBQ	<1.0	<1.0	--	1.56	7.7	1.9
		(replicate)						
		RPD of replicate sample concentrations:	--	--	--	19	0	0
Loop 410	5/14/2013	SB	<1.0	<1.0	--	0.85	5.6	2.1
Loop 410	5/14/2013	SBQ	<1.0	<1.0	<4.0	0.85	5.4	2.0
		(replicate)						
		RPD of replicate sample concentrations:	--	--	--	0	4	5
Loop 410	2/7/2013	SB	<1.0	<1.0	--	0.86	5.2	2.0
Loop 410	2/7/2013	SBQ	<1.0	<1.0	--	0.65	5.2	2.0
		(replicate)						
		RPD of replicate sample concentrations:	--	--	--	28	0	0
Morey Road	2/6/2013	SB	<1.0	<1.0	--	1.58	6.5	1.8
Morey Road	2/6/2013	SBQ	<1.0	<1.0	--	1.55	6.4	2.0
		(replicate)						
		RPD of replicate sample concentrations:	--	--	--	2	2	11
Morey Road	6/25/2013	SB	<1.0	<1.0	<4.0	1.39	6.6	1.7
Morey Road	6/25/2013	SBQ	<1.0	<1.0	<4.0	1.50	6.4	1.6
		(replicate)						
		RPD of replicate sample concentrations:	--	--	--	8	3	6
Loop 410	7/22/2014	SB	<1.0	<1.0	<4.0	0.77	5.0	2.2
Loop 410	7/22/2014	SBQ	<1.0	<1.0	<4.0	0.81	5.0	2.3
		(replicate)						
		RPD of replicate sample concentrations:	--	--	--	5	0	4
Morey Road	5/24/2013	SS	<1.0	<1.0	<4.0	1.37	6.7	1.9
Morey Road	5/24/2013	SSQ	<1.0	<1.0	<4.0	1.66	6.9	1.9
		(replicate)						
		RPD of replicate sample concentrations:	--	--	--	19	3	0
Rodriguez Park	4/30/2013	SS	<1.0	<1.0	--	3.04	7.4	1.7
Rodriguez Park	4/30/2013	SSQ	<1.0	<1.0	--	3.08	7.3	1.7
		(replicate)						
		RPD of replicate sample concentrations:	--	--	--	1	1	0

Table 6. Concentration of organic constituents in U.S. Geological Survey National Water Quality Laboratory quality-control samples included with sample sets for stream-sediment samples collected from Leon Creek, San Antonio, Texas, 2012–14.

[--, no data; <, less than; E, estimated]

Set number	Sample identifier, units	alpha-Endosulfan	Benfluralin	beta-Endosulfan	Chlorpyrifos	cis-Chlordane	cis-Nonachlor
201433804	Blank, micrograms per kilogram	<0.2	<0.2	<0.2	<0.2	<0.2	<0.1
201433804	Spike, percent recovery (acceptable range)	115.2 (21–165)	65.9 (10–124)	132.2 (21–165)	106.2 (19–169)	123.2 (32–170)	122.5 (42–156)
201432811	Blank, micrograms per kilogram	<0.2	<0.2	<0.2	<0.2	<0.2	<0.1
201432811	Spike, percent recovery (acceptable range)	61.0 (21–165)	24.9 (10–124)	111.8 (21–165)	55.8 (19–169)	46.2 (32–170)	49.1 (42–156)
201425501	Blank, micrograms per kilogram	<0.2	<0.2	<0.2	<0.2	<0.2	<0.1
201425501	Spike, percent recovery (acceptable range)	112.6 (21–165)	39.4 (10–124)	139.1 (21–165)	112.4 (19–169)	107.9 (32–170)	111.8 (42–156)
201326608	Blank, micrograms per kilogram	<0.2	<0.2	<0.2	<0.2	<0.2	<0.1
201326608	Spike, percent recovery (acceptable range)	42.0 (21–165)	25.7 (10–124)	43.1 (21–165)	51.7 (19–169)	34.6 (32–170)	27.0 (42–156)
201320406	Blank, micrograms per kilogram	<0.2	<0.2	<0.2	<0.2	<0.2	<0.1
201320406	Spike, percent recovery (acceptable range)	186.9 (21–165)	46.3 (10–124)	258.5 (21–165)	234.0 (19–169)	86.8 (32–170)	130.2 (42–156)
201316313	Blank, micrograms per kilogram	<0.2	<0.2	<0.2	<0.2	<0.2	<0.1
201316313	Spike, percent recovery (acceptable range)	59.9 (21–165)	46.8 (10–124)	79.0 (21–165)	73.9 (19–169)	47.3 (32–170)	51.6 (42–156)
201312803	Blank, micrograms per kilogram	<0.2	<0.2	<0.2	<0.2	<0.2	<0.1
201312803	Spike, percent recovery (acceptable range)	53.5 (21–165)	15.8 (10–124)	63.7 (21–165)	60.9 (19–169)	53.7 (32–170)	56.2 (42–156)
201234302	Blank, micrograms per kilogram	<0.2	<0.2	<0.2	<0.2	<0.2	<0.1
201234302	Spike, percent recovery (acceptable range)	29.4 (21–165)	28.2 (10–124)	70.3 (21–165)	62.0 (19–169)	49.8 (32–170)	57.9 (42–156)

54 Occurrence and Concentrations of Selected Trace Elements and Halogenated Organic Compounds in Stream Sediments
Table 6. Concentration of organic constituents in U.S. Geological Survey National Water Quality Laboratory quality-control samples included with sample sets for stream-sediment samples collected from Leon Creek, San Antonio, Texas, 2012–14.—Continued

[--, no data; <, less than; E, estimated]

Set number	Sample identifier, units	Cyfluthrin	DCPA (Dacthal)	Desulfinyl-fipronil	Dieldrin	Endosulfan sulfate
201433804	Blank, micrograms per kilogram	<0.2	<0.2	<0.1	<0.1	<0.4
201433804	Spike, percent recovery (acceptable range)	128.4 (15–123)	129.9 (52–136)	103.0 (16–148)	123.5 (47–161)	123.9 (21–165)
201432811	Blank, micrograms per kilogram	<0.2	<0.2	<0.1	<0.1	<0.4
201432811	Spike, percent recovery (acceptable range)	49.1 (15–123)	100.4 (52–136)	94.4 (16–148)	64.4 (47–161)	107.6 (21–165)
201425501	Blank, micrograms per kilogram	<0.2	<0.2	<0.1	<0.1	<0.4
201425501	Spike, percent recovery (acceptable range)	119.6 (15–123)	93.2 (52–136)	93.7 (16–148)	125.2 (47–161)	127.7 (21–165)
201326608	Blank, micrograms per kilogram	<0.2	<0.2	<0.1	<0.1	<0.4
201326608	Spike, percent recovery (acceptable range)	43.6 (15–123)	34.1 (52–136)	33.1 (16–148)	39.5 (47–161)	55.2 (21–165)
201320406	Blank, micrograms per kilogram	<0.2	<0.2	<0.1	<0.1	<0.4
201320406	Spike, percent recovery (acceptable range)	504.5 (15–123)	92.3 (52–136)	283.6 (16–148)	89.8 (47–161)	435.3 (21–165)
201316313	Blank, micrograms per kilogram	<0.2	<0.2	<0.1	<0.1	<0.4
201316313	Spike, percent recovery (acceptable range)	66.9 (15–123)	61.9 (52–136)	56.4 (16–148)	51.4 (47–161)	82.6 (21–165)
201312803	Blank, micrograms per kilogram	<0.2	<0.2	<0.1	<0.1	<0.4
201312803	Spike, percent recovery (acceptable range)	77.2 (15–123)	58.2 (52–136)	44.7 (16–148)	45.7 (47–161)	63.0 (21–165)
201234302	Blank, micrograms per kilogram	<0.2	<0.2	<0.1	<0.1	<0.4
201234302	Spike, percent recovery (acceptable range)	64.6 (15–123)	77.8 (52–136)	75.7 (16–148)	46.4 (47–161)	73.8 (21–165)

Table 6. Concentration of organic constituents in U.S. Geological Survey National Water Quality Laboratory quality-control samples included with sample sets for stream-sediment samples collected from Leon Creek, San Antonio, Texas, 2012–14.—Continued

[--, no data; <, less than; E, estimated]

Set number	Sample identifier, units	Fipronil sulfide	Fipronil	Hexachloro-benzene	lambda-Cyhalothrin	Oxychlorane
201433804	Blank, micrograms per kilogram	<0.1	E0.43	0.03	<0.2	<1
201433804	Spike, percent recovery (acceptable range)	100.0 (28–148)	109.6 (33–123)	97.0 (20–158)	104.9 (8–156)	106.7 (32–164)
201432811	Blank, micrograms per kilogram	<0.1	<0.1	0.019	<0.2	<1
201432811	Spike, percent recovery (acceptable range)	94.5 (28–148)	98.5 (33–123)	34.9 (20–158)	36.6 (8–156)	35.8 (32–164)
201425501	Blank, micrograms per kilogram	<0.1	<0.1	0.014	<0.2	<1
201425501	Spike, percent recovery (acceptable range)	97.9 (28–148)	126.0 (33–123)	80.1 (20–158)	74.9(8–156)	106.0 (32–164)
201326608	Blank, micrograms per kilogram	<0.1	--	<0.1	<0.2	<1
201326608	Spike, percent recovery (acceptable range)	26.2 (28–148)	--	14.9 (20–158)	41.6 (8–156)	25.4 (32–164)
201320406	Blank, micrograms per kilogram	<0.1	<0.1	0.013	<0.2	<1
201320406	Spike, percent recovery (acceptable range)	85.7 (28–148)	--	53.1 (20–158)	376.3 (8–156)	72.5 (32–164)
201316313	Blank, micrograms per kilogram	<0.1	<0.1	<0.1	<0.2	<1
201316313	Spike, percent recovery (acceptable range)	40.3 (28–148)	0.0 (33–123)	46.3 (20–158)	45.3(8–156)	40.6 (32–164)
201312803	Blank, micrograms per kilogram	<0.1	--	<0.1	<0.2	<1
201312803	Spike, percent recovery (acceptable range)	46.6 (28–148)	--	21.9 (20–158)	44.4 (8–156)	46.7 (32–164)
201234302	Blank, micrograms per kilogram	<0.1	--	0.019	<0.2	<1
201234302	Spike, percent recovery (acceptable range)	22.6 (28–148)	--	45.4 (20–158)	37.1 (8–156)	33.6 (32–164)

56 Occurrence and Concentrations of Selected Trace Elements and Halogenated Organic Compounds in Stream Sediments
Table 6. Concentration of organic constituents in U.S. Geological Survey National Water Quality Laboratory quality-control samples included with sample sets for stream-sediment samples collected from Leon Creek, San Antonio, Texas, 2012–14.—Continued

[--, no data; <, less than; E, estimated]

Set number	Sample identifier, units	Oxyfluorfen	<i>p,p'</i> -DDD	<i>p,p'</i> -DDE	<i>p,p'</i> -DDT	Pendimethalin
201433804	Blank, micrograms per kilogram	<4	<2	<1	<4	<1
201433804	Spike, percent recovery (acceptable range)	117.4 (33–153)	123.1 (13–147)	119.9 (25–151)	116.8 (22–156)	107.5 (50–146)
201432811	Blank, micrograms per kilogram	<4	<2	<1	<4	<1
201432811	Spike, percent recovery (acceptable range)	71.3 (33–153)	53.6 (13–147)	56.4 (25–151)	52.5 (22–156)	53.3 (50–146)
201425501	Blank, micrograms per kilogram	<4	<2	<1	<4	<1
201425501	Spike, percent recovery (acceptable range)	108.1 (33–153)	115.8 (13–147)	105.5 (25–151)	127.4 (22–156)	86.9 (50–146)
201326608	Blank, micrograms per kilogram	<4	<2	<1	<4	<1
201326608	Spike, percent recovery (acceptable range)	46.0 (33–153)	38.5 (13–147)	30.4 (25–151)	38.6 (22–156)	41.0 (50–146)
201320406	Blank, micrograms per kilogram	<4	<2	<1	<4	<1
201320406	Spike, percent recovery (acceptable range)	96.7 (33–153)	118.5 (13–147)	48.9 (25–151)	222.8 (22–156)	237.0 (50–146)
201316313	Blank, micrograms per kilogram	<4	<2	<1	<4	<1
201316313	Spike, percent recovery (acceptable range)	73.0 (33–153)	51.8 (13–147)	46.0 (25–151)	79.4 (22–156)	65.4 (50–146)
201312803	Blank, micrograms per kilogram	<4	<2	<1	<4	<1
201312803	Spike, percent recovery (acceptable range)	76.5 (33–153)	44.2 (13–147)	58.7 (25–151)	52.8 (22–156)	63.7 (50–146)
201234302	Blank, micrograms per kilogram	<4	<2	<1	<4	<1
201234302	Spike, percent recovery (acceptable range)	72.0 (33–153)	61.9 (13–147)	42.5 (25–151)	52.9 (22–156)	66.7 (50–146)

Table 6. Concentration of organic constituents in U.S. Geological Survey National Water Quality Laboratory quality-control samples included with sample sets for stream-sediment samples collected from Leon Creek, San Antonio, Texas, 2012–14.—Continued

[--, no data; <, less than; E, estimated]

Set number	Sample identifier, units	Penta-chloroanisole	Penta-chloronitro-benzene	Tefluthrin	Tetradifon	<i>trans</i> -Chlordane
201433804	Blank, micrograms per kilogram	<0.1	<0.1	<0.5	<0.2	<0.2
201433804	Spike, percent recovery (acceptable range)	100.2 (35–155)	99.0 (48–162)	103.1 (43–127)	100.0 (60–138)	115.2 (39–165)
201432811	Blank, micrograms per kilogram	<0.1	<0.1	<0.5	<0.2	<0.2
201432811	Spike, percent recovery (acceptable range)	47.7 (35–155)	50.8 (48–162)	39.1 (43–127)	72.5 (60–138)	45.3 (39–165)
201425501	Blank, micrograms per kilogram	<0.1	<0.1	<0.5	<0.2	<0.2
201425501	Spike, percent recovery (acceptable range)	74.1 (35–155)	70.6 (48–162)	101.8 (43–127)	98.5 (60–138)	112.5 (39–165)
201326608	Blank, micrograms per kilogram	<0.1	<0.1	<0.5	<0.2	<0.2
201326608	Spike, percent recovery (acceptable range)	17.3 (35–155)	25.8 (48–162)	36.9 (43–127)	32.3 (60–138)	33.8 (39–165)
201320406	Blank, micrograms per kilogram	<0.1	<0.1	<0.5	<0.2	<0.2
201320406	Spike, percent recovery (acceptable range)	53.6 (35–155)	117.6 (48–162)	71.6 (43–127)	109.8 (60–138)	83.5 (39–165)
201316313	Blank, micrograms per kilogram	<0.1	<0.1	<0.5	<0.2	<0.2
201316313	Spike, percent recovery (acceptable range)	46.8 (35–155)	60.2 (48–162)	52.4 (43–127)	53.2 (60–138)	52.2 (39–165)
201312803	Blank, micrograms per kilogram	<0.1	<0.1	<0.5	<0.2	<0.2
201312803	Spike, percent recovery (acceptable range)	20.9 (35–155)	21.3 (48–162)	49.1 (43–127)	55.4 (60–138)	53.4 (39–165)
201234302	Blank, micrograms per kilogram	<0.1	<0.1	<0.5	<0.2	<0.2
201234302	Spike, percent recovery (acceptable range)	42.7 (35–155)	55.5 (48–162)	40.3 (43–127)	62.5 (60–138)	40.1 (39–165)

58 Occurrence and Concentrations of Selected Trace Elements and Halogenated Organic Compounds in Stream Sediments
Table 6. Concentration of organic constituents in U.S. Geological Survey National Water Quality Laboratory quality-control samples included with sample sets for stream-sediment samples collected from Leon Creek, San Antonio, Texas, 2012–14.—Continued

[--, no data; <, less than; E, estimated]

Set number	Sample identifier, units	<i>trans</i>-Nonachlor	Trifluralin	PCB congener 101	PCB congener 110	PCB congener 118
201433804	Blank, micrograms per kilogram	<0.1	<0.2	<1	<1	<0.1
201433804	Spike, percent recovery (acceptable range)	117.5 (28–160)	67.1 (12–138)	123.6 (10–130)	130.3 (16–130)	124.5 (35–155)
201432811	Blank, micrograms per kilogram	<0.1	<0.2	<1	<1	<0.1
201432811	Spike, percent recovery (acceptable range)	44.1 (28–160)	25.4 (12–138)	51.6 (10–130)	47.7 (16–130)	48.2 (35–155)
201425501	Blank, micrograms per kilogram	<0.1	<0.2	<1	<1	<0.1
201425501	Spike, percent recovery (acceptable range)	109.3 (28–160)	37.0 (12–138)	97.4 (10–130)	101.0 (16–130)	103.2 (35–155)
201326608	Blank, micrograms per kilogram	<0.1	<0.2	<1	<1	<0.1
201326608	Spike, percent recovery (acceptable range)	28.2 (28–160)	24.6 (12–138)	21.5 (10–130)	23.2 (16–130)	25.3 (35–155)
201320406	Blank, micrograms per kilogram	<0.1	<0.2	<1	<1	<0.1
201320406	Spike, percent recovery (acceptable range)	108.6 (28–160)	41.2 (12–138)	40.7 (10–130)	41.6 (16–130)	41.4 (35–155)
201316313	Blank, micrograms per kilogram	<0.1	<0.2	<1	<1	<0.1
201316313	Spike, percent recovery (acceptable range)	51.0 (28–160)	43.1 (12–138)	27.2 (10–130)	26.6 (16–130)	35.0 (35–155)
201312803	Blank, micrograms per kilogram	<0.1	<0.2	<1	<1	<0.1
201312803	Spike, percent recovery (acceptable range)	49.6 (28–160)	14.3 (12–138)	30.8 (10–130)	41.2 (16–130)	29.6 (35–155)
201234302	Blank, micrograms per kilogram	<0.1	<0.2	<1	<1	<0.1
201234302	Spike, percent recovery (acceptable range)	45.3 (28–160)	32.8 (12–138)	9.2 (10–130)	28.6 (16–130)	56.0 (35–155)

Table 6. Concentration of organic constituents in U.S. Geological Survey National Water Quality Laboratory quality-control samples included with sample sets for stream-sediment samples collected from Leon Creek, San Antonio, Texas, 2012–14.—Continued

[--, no data; <, less than; E, estimated]

Set number	Sample identifier, units	PCB congener 138	PCB congener 146	PCB congener 149	PCB congener 151	PCB congener 170
201433804	Blank, micrograms per kilogram	<0.1	<0.1	<1	<0.1	<0.1
201433804	Spike, percent recovery (acceptable range)	122.8 (27–155)	121.3 (37–145)	115.9 (12–114)	117.3 (21–141)	119.8 (28–154)
201432811	Blank, micrograms per kilogram	<0.1	<0.1	<1	<0.1	<0.1
201432811	Spike, percent recovery (acceptable range)	49.7 (27–155)	47.5 (37–145)	45.3 (12–114)	45.3 (21–141)	49.7 (28–154)
201425501	Blank, micrograms per kilogram	<0.1	<0.1	<1	<0.1	<0.1
201425501	Spike, percent recovery (acceptable range)	101.4 (27–155)	102.7 (37–145)	100.1 (12–114)	95.6 (21–141)	98.4 (28–154)
201326608	Blank, micrograms per kilogram	<0.1	<0.1	<1	<0.1	<0.1
201326608	Spike, percent recovery (acceptable range)	21.1 (27–155)	21.2 (37–145)	21.6 (12–114)	20.5 (21–141)	21.4 (28–154)
201320406	Blank, micrograms per kilogram	<0.1	<0.1	<1	<0.1	<0.1
201320406	Spike, percent recovery (acceptable range)	43.2 (27–155)	36.0 (37–145)	38.9 (12–114)	40.5 (21–141)	44.0 (28–154)
201316313	Blank, micrograms per kilogram	<0.1	<0.1	<1	<0.1	<0.1
201316313	Spike, percent recovery (acceptable range)	26.0 (27–155)	27.4 (37–145)	44.9 (12–114)	25.7 (21–141)	27.9 (28–154)
201312803	Blank, micrograms per kilogram	<0.1	<0.1	<1	<0.1	<0.1
201312803	Spike, percent recovery (acceptable range)	33.4 (27–155)	29.9 (37–145)	31.7 (12–114)	34.7 (21–141)	29.3 (28–154)
201234302	Blank, micrograms per kilogram	<0.1	<0.1	<1	<0.1	<0.1
201234302	Spike, percent recovery (acceptable range)	21.3 (27–155)	46.6 (37–145)	10.9 (12–114)	56.9 (21–141)	69.6 (28–154)

60 Occurrence and Concentrations of Selected Trace Elements and Halogenated Organic Compounds in Stream Sediments
Table 6. Concentration of organic constituents in U.S. Geological Survey National Water Quality Laboratory quality-control samples included with sample sets for stream-sediment samples collected from Leon Creek, San Antonio, Texas, 2012–14.—Continued

[--, no data; <, less than; E, estimated]

Set number	Sample identifier, units	PCB congener 174	PCB congener 177	PCB congener 180	PCB congener 183	PCB congener 187
201433804	Blank, micrograms per kilogram	<0.1	<0.1	<0.1	<0.1	<0.1
201433804	Spike, percent recovery (acceptable range)	118.5 (51–135)	119.4 (38–140)	121.4 (40–142)	119.1 (34–142)	116.9 (33–153)
201432811	Blank, micrograms per kilogram	<0.1	<0.1	<0.1	<0.1	<0.1
201432811	Spike, percent recovery (acceptable range)	46.9 (51–135)	47.5 (38–140)	49.0 (40–142)	46.1 (34–142)	46.4 (33–153)
201425501	Blank, micrograms per kilogram	<0.1	<0.1	0.009	<0.1	<0.1
201425501	Spike, percent recovery (acceptable range)	97.6 (51–135)	96.9 (38–140)	100.0 (40–142)	97.6 (34–142)	96.2 (33–153)
201326608	Blank, micrograms per kilogram	<0.1	<0.1	<0.1	<0.1	<0.1
201326608	Spike, percent recovery (acceptable range)	20.8 (51–135)	20.7 (38–140)	20.8 (40–142)	20.8 (34–142)	20.7 (33–153)
201320406	Blank, micrograms per kilogram	<0.1	<0.1	<0.1	<0.1	<0.1
201320406	Spike, percent recovery (acceptable range)	42.6 (51–135)	42.4 (38–140)	42.7 (40–142)	40.5 (34–142)	40.5 (33–153)
201316313	Blank, micrograms per kilogram	<0.1	<0.1	<0.1	<0.1	<0.1
201316313	Spike, percent recovery (acceptable range)	27.0 (51–135)	26.8 (38–140)	27.9 (40–142)	26.4 (34–142)	26.0 (33–153)
201312803	Blank, micrograms per kilogram	<0.1	<0.1	<0.1	<0.1	<0.1
201312803	Spike, percent recovery (acceptable range)	30.5 (51–135)	29.9 (38–140)	29.4 (40–142)	30.9 (34–142)	29.8 (33–153)
201234302	Blank, micrograms per kilogram	<0.1	<0.1	<0.1	<0.1	<0.1
201234302	Spike, percent recovery (acceptable range)	25.0 (51–135)	21.9 (38–140)	66.4 (40–142)	64.3 (34–142)	61.5 (33–153)

Table 6. Concentration of organic constituents in U.S. Geological Survey National Water Quality Laboratory quality-control samples included with sample sets for stream-sediment samples collected from Leon Creek, San Antonio, Texas, 2012–14.—Continued

[--, no data; <, less than; E, estimated]

Set number	Sample identifier, units	PCB congener 194	PCB congener 206	PCB congener 49	PCB congener 52	PCB congener 70
201433804	Blank, micrograms per kilogram	<0.1	<0.1	<2	<1	<2
201433804	Spike, percent recovery (acceptable range)	118.0 (57–135)	118.7 (66–120)	135.1 (9–113)	123.2 (4–112)	131.2 (9–115)
201432811	Blank, micrograms per kilogram	<0.1	<0.1	<2	<1	<2
201432811	Spike, percent recovery (acceptable range)	49.4 (57–135)	50.1 (66–120)	60.7 (9–113)	43.7 (4–112)	48.5 (9–115)
201425501	Blank, micrograms per kilogram	<0.1	<0.1	<2	<1	<2
201425501	Spike, percent recovery (acceptable range)	98.6 (57–135)	96.5 (66–120)	106.9 (9–113)	91.5 (4–112)	112.7 (9–115)
201326608	Blank, micrograms per kilogram	<0.1	<0.1	<2	<1	<2
201326608	Spike, percent recovery (acceptable range)	21.5 (57–135)	21.9 (66–120)	19.1 (9–113)	21.8 (4–112)	21.9 (9–115)
201320406	Blank, micrograms per kilogram	<0.1	<0.1	<2	<1	<2
201320406	Spike, percent recovery (acceptable range)	45.7 (57–135)	40.6 (66–120)	38.4 (9–113)	35.3 (4–112)	37.5 (9–115)
201316313	Blank, micrograms per kilogram	<0.1	<0.1	<2	<1	<2
201316313	Spike, percent recovery (acceptable range)	28.7 (57–135)	30.3 (66–120)	28.2 (9–113)	39.2 (4–112)	34.5 (9–115)
201312803	Blank, micrograms per kilogram	<0.1	<0.1	<2	<1	<2
201312803	Spike, percent recovery (acceptable range)	29.8 (57–135)	30.6 (66–120)	44.8 (9–113)	31.5 (4–112)	30.5 (9–115)
201234302	Blank, micrograms per kilogram	<0.1	<0.1	<2	<1	<2
201234302	Spike, percent recovery (acceptable range)	20.3 (57–135)	30.3 (66–120)	18.0 (9–113)	24.0 (4–112)	49.5 (9–115)

62 Occurrence and Concentrations of Selected Trace Elements and Halogenated Organic Compounds in Stream Sediments
Table 6. Concentration of organic constituents in U.S. Geological Survey National Water Quality Laboratory quality-control samples included with sample sets for stream-sediment samples collected from Leon Creek, San Antonio, Texas, 2012–14.—Continued

[--, no data; <, less than; E, estimated]

Set number	Sample identifier, units	1,2-Bis(2,4,6-tribromo-phenoxy)-ethane	PBDE congener 100	PBDE congener 138	PBDE congener 153	PBDE congener 154
201433804	Blank, micrograms per kilogram	<0.1	<0.1	<0.1	<0.1	<0.1
201433804	Spike, percent recovery (acceptable range)	126.3 (49–157)	124.1 (27–159)	104.1 (28–166)	125.4 (38–158)	117.9 (47–143)
201432811	Blank, micrograms per kilogram	<0.1	<0.1	<0.1	<0.1	<0.1
201432811	Spike, percent recovery (acceptable range)	55.1 (49–157)	67.7 (27–159)	48.9 (28–166)	52.1 (38–158)	52.8 (47–143)
201425501	Blank, micrograms per kilogram	<0.1	0.051	<0.1	<0.1	<0.1
201425501	Spike, percent recovery (acceptable range)	114.4 (49–157)	118.8 (27–159)	122.0 (28–166)	127.8 (38–158)	132.8 (47–143)
201326608	Blank, micrograms per kilogram	<0.1	0.12	<0.1	<0.1	<0.1
201326608	Spike, percent recovery (acceptable range)	42.6 (49–157)	60.0 (27–159)	48.1 (28–166)	45.7 (38–158)	46.2 (47–143)
201320406	Blank, micrograms per kilogram	<0.1	0.012	<0.1	<0.1	<0.1
201320406	Spike, percent recovery (acceptable range)	194.9 (49–157)	112.9 (27–159)	198.3 (28–166)	123.9 (38–158)	116.4 (47–143)
201316313	Blank, micrograms per kilogram	<0.1	<0.1	<0.1	<0.1	<0.1
201316313	Spike, percent recovery (acceptable range)	149.7 (49–157)	58.0 (27–159)	89.9 (28–166)	79.7 (38–158)	65.3 (47–143)
201312803	Blank, micrograms per kilogram	<0.1	0.19	<0.1	<0.1	<0.1
201312803	Spike, percent recovery (acceptable range)	72.7 (49–157)	58.2 (27–159)	70.2 (28–166)	56.6 (38–158)	53.5 (47–143)
201234302	Blank, micrograms per kilogram	<0.1	0.086	<0.1	<0.1	<0.1
201234302	Spike, percent recovery (acceptable range)	61.6 (49–157)	99.9 (27–159)	56.5 (28–166)	68.4 (38–158)	61.6 (47–143)

Table 6. Concentration of organic constituents in U.S. Geological Survey National Water Quality Laboratory quality-control samples included with sample sets for stream-sediment samples collected from Leon Creek, San Antonio, Texas, 2012–14.—Continued

[--, no data; <, less than; E, estimated]

Set number	Sample identifier, units	PBDE congener 183	PBDE congener 47	PBDE congener 66	PBDE congener 71	PBDE congener 85
201433804	Blank, micrograms per kilogram	<0.1	0.16	<0.1	<0.1	<0.1
201433804	Spike, percent recovery (acceptable range)	108.4 (36–162)	194.0 (24–192)	122.7 (11–137)	125.9 (37–163)	115.6 (36–168)
201432811	Blank, micrograms per kilogram	<0.1	0.31	<0.1	0.28	<0.1
201432811	Spike, percent recovery (acceptable range)	53.5 (36–162)	226.1 (24–192)	57.5 (11–137)	48.7 (37–163)	51.9 (36–168)
201425501	Blank, micrograms per kilogram	<0.1	0.25	<0.1	<0.1	<0.1
201425501	Spike, percent recovery (acceptable range)	107.2 (36–162)	188.1 (24–192)	124.5 (11–137)	124.4 (37–163)	133.0 (36–168)
201326608	Blank, micrograms per kilogram	<0.1	1.3	<0.1	<0.1	<0.1
201326608	Spike, percent recovery (acceptable range)	41.4 (36–162)	318.2 (24–192)	45.1 (11–137)	39.3 (37–163)	49.8 (36–168)
201320406	Blank, micrograms per kilogram	<0.1	0.32	<0.1	<0.1	<0.1
201320406	Spike, percent recovery (acceptable range)	241.3 (36–162)	179.9 (24–192)	107.6 (11–137)	98.8 (37–163)	154.8 (36–168)
201316313	Blank, micrograms per kilogram	<0.1	0.17	<0.1	<0.1	<0.1
201316313	Spike, percent recovery (acceptable range)	85.4 (36–162)	112.7 (24–192)	65.6 (11–137)	54.8 (37–163)	79.4 (36–168)
201312803	Blank, micrograms per kilogram	<0.1	0.3	<0.1	<0.1	<0.1
201312803	Spike, percent recovery (acceptable range)	69.5 (36–162)	116.0 (24–192)	58.3 (11–137)	55.2 (37–163)	62.8 (36–168)
201234302	Blank, micrograms per kilogram	<0.1	1.2	<0.1	<0.1	<0.1
201234302	Spike, percent recovery (acceptable range)	64.0 (36–162)	280.7 (24–192)	58.6 (11–137)	58.4 (37–163)	69.0 (36–168)

64 Occurrence and Concentrations of Selected Trace Elements and Halogenated Organic Compounds in Stream Sediments
Table 6. Concentration of organic constituents in U.S. Geological Survey National Water Quality Laboratory quality-control samples included with sample sets for stream-sediment samples collected from Leon Creek, San Antonio, Texas, 2012–14.—Continued

[--, no data; <, less than; E, estimated]

Set number	Sample identifier, units	PBDE congener 99	Bis(hexachloro-cyclopentadieno) cyclooctane	Methyl triclosan	Octachloro-styrene	Pentabromo-toluene	Triclosan
201433804	Blank, micrograms per kilogram	0.043	<1	<6	<1	<1	<4
201433804	Spike, percent recovery (acceptable range)	133.5 (27–183)	119.2 (44–170)	60.8 (30–156)	114.8 (42–126)	112.6 (69–141)	4.7 (14–170)
201432811	Blank, micrograms per kilogram	0.11	<1	<6	<1	<1	E1.4
201432811	Spike, percent recovery (acceptable range)	109.7 (27–183)	53.4 (44–170)	30.4 (30–156)	39.3 (42–126)	48.5 (69–141)	28.9 (14–170)
201425501	Blank, micrograms per kilogram	0.16	<1	<6	<1	<1	<4
201425501	Spike, percent recovery (acceptable range)	158.6 (27–183)	111.4 (44–170)	118.7 (30–156)	92.5 (42–126)	114.8 (69–141)	2.8 (14–170)
201326608	Blank, micrograms per kilogram	0.39	<1	<6	<1	<1	<4
201326608	Spike, percent recovery (acceptable range)	93.3 (27–183)	40.9 (44–170)	40.8 (30–156)	25.5 (42–126)	38.1 (69–141)	7.7 (14–170)
201320406	Blank, micrograms per kilogram	0.078	<1	<6	<1	<1	<4
201320406	Spike, percent recovery (acceptable range)	137.8 (27–183)	128.9 (44–170)	85.6 (30–156)	49.6 (42–126)	132.6 (69–141)	50.0 (14–170)
201316313	Blank, micrograms per kilogram	0.073	<1	<6	<1	<1	<4
201316313	Spike, percent recovery (acceptable range)	73.1 (27–183)	80.4 (44–170)	56.7 (30–156)	46.7 (42–126)	64.4 (69–141)	0.0 (14–170)
201312803	Blank, micrograms per kilogram	0.085	<1	<6	<1	<1	--
201312803	Spike, percent recovery (acceptable range)	71.1 (27–183)	58.8 (44–170)	51.4 (30–156)	42.1 (42–126)	64.0 (69–141)	--
201234302	Blank, micrograms per kilogram	0.23	<1	<6	<1	<1	--
201234302	Spike, percent recovery (acceptable range)	218.6 (27–183)	60.0 (44–170)	58.9 (30–156)	47.4 (42–126)	58.8 (69–141)	--

Table 8. Concentrations of inorganic and organic constituents in streambed- and suspended-sediment samples collected from sites on Leon Creek, San Antonio, Texas, 2012–14.

[QC, quality control; NWQL, U.S. Geological Survey National Water Quality Laboratory; SB, bottom material; SBQ, QC sample - bottom material; SS, suspended sediment; SSQ, QC sample - suspended sediment; --, no data; <, less than; E, estimated; M, presence verified but not quantified; b, value extrapolated at low end; h, compound identified and verified after additional review; m, value is highly variable by this method; n, below the reporting level but at or above the detection level; t, below the detection level; v, analyte detected in laboratory blank]

Station number	Station name	Site identifier (table 1)	Date	Medium code (QC sample type)	NWQL set number	Calcium (milligrams per kilogram)	Magnesium (milligrams per kilogram)
08181435	Leon Creek at Loop 410 at San Antonio, Tex.	Loop 410	11/15/2012	SB	201234302	210,000	5,800
08181435	Leon Creek at Loop 410 at San Antonio, Tex.	Loop 410	11/15/2012	SBQ (replicate)	201234302	200,000	5,700
08181435	Leon Creek at Loop 410 at San Antonio, Tex.	Loop 410	01/09/2013	SS	201312803	Insufficient sediment	Insufficient sediment
08181435	Leon Creek at Loop 410 at San Antonio, Tex.	Loop 410	02/07/2013	SB	201312803	210,000	5,800
08181435	Leon Creek at Loop 410 at San Antonio, Tex.	Loop 410	02/07/2013	SBQ (replicate)	201316313	200,000	5,800
08181435	Leon Creek at Loop 410 at San Antonio, Tex.	Loop 410	04/29/2013	SS	201316313	190,000	5,500
08181435	Leon Creek at Loop 410 at San Antonio, Tex.	Loop 410	05/14/2013	SB	201316313	190,000	6,000
08181435	Leon Creek at Loop 410 at San Antonio, Tex.	Loop 410	05/14/2013	SBQ (replicate)	201320406	200,000	5,900
08181435	Leon Creek at Loop 410 at San Antonio, Tex.	Loop 410	05/24/2013	SS	201320406	200,000	5,700
08181435	Leon Creek at Loop 410 at San Antonio, Tex.	Loop 410	06/25/2013	SB	201326608	180,000	7,200
08181435	Leon Creek at Loop 410 at San Antonio, Tex.	Loop 410	06/25/2014	SS	201425501	170,000	6,200
08181435	Leon Creek at Loop 410 at San Antonio, Tex.	Loop 410	07/22/2014	SB	201432811	210,000	6,300
08181435	Leon Creek at Loop 410 at San Antonio, Tex.	Loop 410	07/22/2014	SBQ (replicate)	201432811	210,000	6,300
292443098364600	Leon Creek at Rodriguez Park, San Antonio, Tex.	Rodriguez Park	11/15/2012	SB	201234302	160,000	6,000
292443098364600	Leon Creek at Rodriguez Park, San Antonio, Tex.	Rodriguez Park	02/07/2013	SB	201312803	170,000	5,900
292443098364600	Leon Creek at Rodriguez Park, San Antonio, Tex.	Rodriguez Park	04/29/2013	SS	201316313	150,000	5,800
292443098364600	Leon Creek at Rodriguez Park, San Antonio, Tex.	Rodriguez Park	04/29/2013	SSQ (replicate)	201316313	150,000	5,600
292443098364600	Leon Creek at Rodriguez Park, San Antonio, Tex.	Rodriguez Park	05/14/2013	SB	201320406	160,000	6,200
292443098364600	Leon Creek at Rodriguez Park, San Antonio, Tex.	Rodriguez Park	05/24/2013	SS	201320406	160,000	5,800
292443098364600	Leon Creek at Rodriguez Park, San Antonio, Tex.	Rodriguez Park	06/24/2013	SB	201326608	160,000	6,200
292443098364600	Leon Creek at Rodriguez Park, San Antonio, Tex.	Rodriguez Park	06/25/2014	SS	201425501	120,000	7,300
292443098364600	Leon Creek at Rodriguez Park, San Antonio, Tex.	Rodriguez Park	07/21/2014	SB	201433804	160,000	6,000
292338098360501	Leon Creek at Morey Road, San Antonio, Tex.	Morey Road	11/15/2012	SB	201234302	150,000	6,900
292338098360501	Leon Creek at Morey Road, San Antonio, Tex.	Morey Road	01/09/2013	SS	--	Insufficient sediment	Insufficient sediment

66 Occurrence and Concentrations of Selected Trace Elements and Halogenated Organic Compounds in Stream Sediments

Table 8. Concentrations of inorganic and organic constituents in streambed- and suspended-sediment samples collected from sites on Leon Creek, San Antonio, Texas, 2012–14.—Continued

[QC, quality control; NWQL, U.S. Geological Survey National Water Quality Laboratory; SB, bottom material; SBQ, QC sample - bottom material; SS, suspended sediment; SSQ, QC sample - suspended sediment; --, no data; <, less than; E, estimated; M, presence verified but not quantified; b, value extrapolated at low end; h, compound identified and verified after additional review; m, value is highly variable by this method; n, below the reporting level but at or above the detection level; t, below the detection level; v, analyte detected in laboratory blank]

Station number	Station name	Site identifier (table 1)	Date	Medium code (QC sample type)	NWQL set number	Calcium (milligrams per kilogram)	Magnesium (milligrams per kilogram)
292338098360501	Leon Creek at Morey Road, San Antonio, Tex.	Morey Road	02/06/2013	SB	201312803	160,000	6,300
292338098360501	Leon Creek at Morey Road, San Antonio, Tex.	Morey Road	02/06/2013	SBQ (replicate)	201316313	160,000	6,100
292338098360501	Leon Creek at Morey Road, San Antonio, Tex.	Morey Road	04/29/2013	SS	201316313	Insufficient sediment	Insufficient sediment
292338098360501	Leon Creek at Morey Road, San Antonio, Tex.	Morey Road	05/13/2013	SB	201320406	160,000	6,200
292338098360501	Leon Creek at Morey Road, San Antonio, Tex.	Morey Road	05/24/2013	SS	201320406	150,000	6,000
292338098360501	Leon Creek at Morey Road, San Antonio, Tex.	Morey Road	05/24/2013	SSQ (replicate)	201320406	130,000	6,200
292338098360501	Leon Creek at Morey Road, San Antonio, Tex.	Morey Road	06/25/2013	SB	201320406	160,000	6,500
292338098360501	Leon Creek at Morey Road, San Antonio, Tex.	Morey Road	06/25/2013	SBQ (replicate)	201320406	140,000	6,000
292338098360501	Leon Creek at Morey Road, San Antonio, Tex.	Morey Road	06/25/2014	SS	201425501	110,000	8,000
292338098360501	Leon Creek at Morey Road, San Antonio, Tex.	Morey Road	07/21/2014	SB	201433804	160,000	6,800
292240098353600	Leon Creek at Lackland Air Force Base Golf Course, San Antonio, Tex.	Joint Base	11/16/2012	SB	201234302	120,000	7,300
292240098353600	Leon Creek at Lackland Air Force Base Golf Course, San Antonio, Tex.	Joint Base	11/16/2012	SBQ (replicate)	201234302	120,000	7,200
292240098353600	Leon Creek at Lackland Air Force Base Golf Course, San Antonio, Tex.	Joint Base	02/06/2013	SB	201312803	120,000	6,900
292240098353600	Leon Creek at Lackland Air Force Base Golf Course, San Antonio, Tex.	Joint Base	05/13/2013	SB	201316313	120,000	6,500
292240098353600	Leon Creek at Lackland Air Force Base Golf Course, San Antonio, Tex.	Joint Base	06/24/2013	SB	201320406	130,000	7,600
292240098353600	Leon Creek at Lackland Air Force Base Golf Course, San Antonio, Tex.	Joint Base	07/21/2014	SB	201433804	120,000	6,700
88480206	USGS Central Tex. PO at Ferguson Ln, Austin, Tex.	--	11/28/2012	SBQ (standard reference material)	201235310	23,000	11,000
88480206	USGS Central Tex. PO at Ferguson Ln, Austin, Tex.	--	04/09/2013	SBQ (standard reference material)	201316313	25,000	11,000

Table 8. Concentrations of inorganic and organic constituents in streambed- and suspended-sediment samples collected from sites on Leon Creek, San Antonio, Texas, 2012–14.—Continued

[QC, quality control; NWQL, U.S. Geological Survey National Water Quality Laboratory; SB, bottom material; SBQ, QC sample - bottom material; SS, suspended sediment; SSQ, QC sample - suspended sediment; --, no data; <, less than; E, estimated; M, presence verified but not quantified; b, value extrapolated at low end; h, compound identified and verified after additional review; m, value is highly variable by this method; n, below the reporting level but at or above the detection level; t, below the detection level; v, analyte detected in laboratory blank]

Site identifier (table 1)	Date	Medium code (QC sample type)	Potassium (milligrams per kilogram)	Sodium (milligrams per kilogram)	Carbon [inorganic plus organic] (percent)	Inorganic carbon (percent)	Phosphorus (milligrams per kilogram)	Aluminum (milligrams per kilogram)
Loop 410	11/15/2012	SB	9,600	820	6.5	5.9	590	37,000
Loop 410	11/15/2012	SBQ (replicate)	9,300	780	6.0	5.8	560	37,000
Loop 410	01/09/2013	SS	Insufficient sediment	Insufficient sediment	Insufficient sediment	Insufficient sediment	Insufficient sediment	Insufficient sediment
Loop 410	02/07/2013	SB	8,800	760	6.9	6.0	590	36,000
Loop 410	02/07/2013	SBQ (replicate)	8,600	740	6.8	6.1	570	36,000
Loop 410	04/29/2013	SS	7,100	700	10	5.9	1,100	34,000
Loop 410	05/14/2013	SB	8,800	800	6.8	5.9	600	36,000
Loop 410	05/14/2013	SBQ (replicate)	8,600	770	6.8	6.0	610	35,000
Loop 410	05/24/2013	SS	7,300	930	7.8	6.1	680	30,000
Loop 410	06/25/2013	SB	10,000	900	5.6	5.0	680	41,000
Loop 410	06/25/2014	SS	7,600	760	Insufficient sediment	Insufficient sediment	920	44,000
Loop 410	07/22/2014	SB	9,200	830	7.2	6.5	620	33,000
Loop 410	07/22/2014	SBQ (replicate)	8,900	770	7.4	6.6	610	31,000
Rodriguez Park	11/15/2012	SB	8,900	1,200	6.0	4.5	650	42,000
Rodriguez Park	02/07/2013	SB	8,600	1,200	6.5	4.9	650	40,000
Rodriguez Park	04/29/2013	SS	10,000	700	7.5	4.5	1,000	49,000
Rodriguez Park	04/29/2013	SSQ (replicate)	9,600	800	7.7	4.6	1,000	47,000
Rodriguez Park	05/14/2013	SB	7,900	1,200	5.6	4.8	630	39,000
Rodriguez Park	05/24/2013	SS	9,100	1,100	6.7	4.8	750	38,000
Rodriguez Park	06/24/2013	SB	8,800	1,100	6.6	4.9	730	35,000
Rodriguez Park	06/25/2014	SS	8,700	710	Insufficient sediment	Insufficient sediment	1,200	52,000

68 Occurrence and Concentrations of Selected Trace Elements and Halogenated Organic Compounds in Stream Sediments

Table 8. Concentrations of inorganic and organic constituents in streambed- and suspended-sediment samples collected from sites on Leon Creek, San Antonio, Texas, 2012–14.—Continued

[QC, quality control; NWQL, U.S. Geological Survey National Water Quality Laboratory; SB, bottom material; SBQ, QC sample - bottom material; SS, suspended sediment; SSQ, QC sample - suspended sediment; --, no data; <, less than; E, estimated; M, presence verified but not quantified; b, value extrapolated at low end; h, compound identified and verified after additional review; m, value is highly variable by this method; n, below the reporting level but at or above the detection level; t, below the detection level; v, analyte detected in laboratory blank]

Site identifier (table 1)	Date	Medium code (QC sample type)	Potassium (milligrams per kilogram)	Sodium (milligrams per kilogram)	Carbon [inorganic plus organic] (percent)	Inorganic carbon (percent)	Phosphorus (milligrams per kilogram)	Aluminum (milligrams per kilogram)
Rodriguez Park	07/21/2014	SB	9,000	1,000	6.8	4.7	740	41,000
Morey Road	11/15/2012	SB	10,000	1,800	5.6	4.0	1,000	49,000
Morey Road	01/09/2013	SS	Insufficient sediment	Insufficient sediment	Insufficient sediment	Insufficient sediment	Insufficient sediment	Insufficient sediment
Morey Road	02/06/2013	SB	10,000	2,200	6.3	4.7	940	43,000
Morey Road	02/06/2013	SBQ (replicate)	9,800	2,100	6.2	4.6	910	44,000
Morey Road	04/29/2013	SS	Insufficient sediment	Insufficient sediment	8.5	3.9	Insufficient sediment	Insufficient sediment
Morey Road	05/13/2013	SB	9,200	1,800	6.0	4.8	1,000	42,000
Morey Road	05/24/2013	SS	10,000	4,170	5.8	4.4	810	38,000
Morey Road	05/24/2013	SSQ (replicate)	11,000	4,660	5.5	3.8	810	42,000
Morey Road	06/25/2013	SB	11,000	2,100	6.0	4.6	1,000	38,000
Morey Road	06/25/2013	SBQ (replicate)	10,000	2,100	6.0	4.5	980	34,000
Morey Road	06/25/2014	SS	10,000	1,370	Insufficient sediment	Insufficient sediment	1,300	59,000
Morey Road	07/21/2014	SB	9,900	1,900	6.4	4.7	980	43,000
Joint Base	11/16/2012	SB	11,000	3,300	5.0	3.1	790	50,000
Joint Base	11/16/2012	SBQ (replicate)	11,000	3,400	4.8	3.2	780	50,000
Joint Base	02/06/2013	SB	11,000	3,400	5.4	3.7	860	45,000
Joint Base	05/13/2013	SB	10,000	3,000	5.0	3.9	790	43,000
Joint Base	06/24/2013	SB	12,000	3,100	5.1	3.7	880	42,000
Joint Base	07/21/2014	SB	11,000	3,000	5.8	3.8	920	44,000
--	11/28/2012	SBQ (standard reference material)	18,000	5,400	3.4	0.82	850	59,000
--	04/09/2013	SBQ (standard reference material)	19,000	5,600	3.1	0.87	880	60,000

Table 8. Concentrations of inorganic and organic constituents in streambed- and suspended-sediment samples collected from sites on Leon Creek, San Antonio, Texas, 2012–14.—Continued

[QC, quality control; NWQL, U.S. Geological Survey National Water Quality Laboratory; SB, bottom material; SBQ, QC sample - bottom material; SS, suspended sediment; SSQ, QC sample - suspended sediment; --, no data; <, less than; E, estimated; M, presence verified but not quantified; b, value extrapolated at low end; h, compound identified and verified after additional review; m, value is highly variable by this method; n, below the reporting level but at or above the detection level; t, below the detection level; v, analyte detected in laboratory blank]

Site identifier (table 1)	Date	Medium code (QC sample type)	Barium (milligrams per kilogram)	Beryllium (milligrams per kilogram)	Bismuth (milligrams per kilogram)	Cadmium (milligrams per kilogram)	Cesium (milligrams per kilogram)	Chromium (milligrams per kilogram)
Loop 410	11/15/2012	SB	150	0.9	0.15	0.3	5.40	42
Loop 410	11/15/2012	SBQ (replicate)	150	1.0	0.15	0.3	5.40	40
Loop 410	01/09/2013	SS	Insufficient sediment	Insufficient sediment	Insufficient sediment	Insufficient sediment	Insufficient sediment	Insufficient sediment
Loop 410	02/07/2013	SB	150	0.8	0.15	0.3	4.80	35
Loop 410	02/07/2013	SBQ (replicate)	140	0.7	0.15	0.3	4.80	34
Loop 410	04/29/2013	SS	170	1.0	M	0.5	<5.00	31
Loop 410	05/14/2013	SB	140	0.8	0.16	0.3	5.20	38
Loop 410	05/14/2013	SBQ (replicate)	140	0.8	0.17	0.3	5.10	37
Loop 410	05/24/2013	SS	150	1.0	M	0.3	4.00	33
Loop 410	06/25/2013	SB	230	1.4	0.20	0.3	7.30	47
Loop 410	06/25/2014	SS	190	1.0	M	0.4	M	40
Loop 410	07/22/2014	SB	140	0.9	0.13	0.3	5.00	42
Loop 410	07/22/2014	SBQ (replicate)	140	1.0	0.13	0.3	4.80	40
Rodriguez Park	11/15/2012	SB	200	1.3	0.22	0.3	4.70	39
Rodriguez Park	02/07/2013	SB	180	1.0	0.19	0.3	4.40	34
Rodriguez Park	04/29/2013	SS	200	1.0	M	0.4	6	37
Rodriguez Park	04/29/2013	SSQ (replicate)	200	1.0	M	0.4	5	34
Rodriguez Park	05/14/2013	SB	190	1.0	0.20	0.3	4.40	34
Rodriguez Park	05/24/2013	SS	200	1.0	M	0.3	4.80	36
Rodriguez Park	06/24/2013	SB	200	1.3	0.18	0.3	4.70	35
Rodriguez Park	06/25/2014	SS	230	2.0	M	0.4	M	45

70 Occurrence and Concentrations of Selected Trace Elements and Halogenated Organic Compounds in Stream Sediments

Table 8. Concentrations of inorganic and organic constituents in streambed- and suspended-sediment samples collected from sites on Leon Creek, San Antonio, Texas, 2012–14.—Continued

[QC, quality control; NWQL, U.S. Geological Survey National Water Quality Laboratory; SB, bottom material; SBQ, QC sample - bottom material; SS, suspended sediment; SSQ, QC sample - suspended sediment; --, no data; <, less than; E, estimated; M, presence verified but not quantified; b, value extrapolated at low end; h, compound identified and verified after additional review; m, value is highly variable by this method; n, below the reporting level but at or above the detection level; t, below the detection level; v, analyte detected in laboratory blank]

Site identifier (table 1)	Date	Medium code (QC sample type)	Barium (milligrams per kilogram)	Beryllium (milligrams per kilogram)	Bismuth (milligrams per kilogram)	Cadmium (milligrams per kilogram)	Cesium (milligrams per kilogram)	Chromium (milligrams per kilogram)
Rodriguez Park	07/21/2014	SB	200	1.3	0.20	0.3	4.90	38
Morey Road	11/15/2012	SB	220	1.5	0.24	0.3	5.30	50
Morey Road	01/09/2013	SS	Insufficient sediment	Insufficient sediment	Insufficient sediment	Insufficient sediment	Insufficient sediment	Insufficient sediment
Morey Road	02/06/2013	SB	190	1.1	0.21	0.3	4.50	43
Morey Road	02/06/2013	SBQ (replicate)	190	1.1	0.21	0.3	4.50	41
Morey Road	04/29/2013	SS	Insufficient sediment	Insufficient sediment	Insufficient sediment	Insufficient sediment	Insufficient sediment	Insufficient sediment
Morey Road	05/13/2013	SB	190	1.0	0.20	0.3	4.60	44
Morey Road	05/24/2013	SS	220	1.0	M	0.2	4.10	38
Morey Road	05/24/2013	SSQ (replicate)	230	1.0	M	0.2	4.40	39
Morey Road	06/25/2013	SB	230	1.3	0.18	0.3	4.90	42
Morey Road	06/25/2013	SBQ (replicate)	220	1.3	0.17	0.3	4.70	40
Morey Road	06/25/2014	SS	240	2.0	M	0.6	M	52
Morey Road	07/21/2014	SB	220	1.3	0.21	0.3	5.00	47
Joint Base	11/16/2012	SB	260	1.3	0.27	0.6	4.80	55
Joint Base	11/16/2012	SBQ (replicate)	260	1.1	0.27	0.5	4.90	58
Joint Base	02/06/2013	SB	230	1.1	0.24	0.5	4.30	50
Joint Base	05/13/2013	SB	230	1.0	0.24	1.5	4.40	48
Joint Base	06/24/2013	SB	270	1.5	0.25	0.9	5.00	53
Joint Base	07/21/2014	SB	240	1.3	0.23	0.9	4.80	51
--	11/28/2012	SBQ (standard reference material)	400	1.8	0.63	2.9	5.60	110
--	04/09/2013	SBQ (standard reference material)	380	1.6	0.54	3.0	5.70	110

Table 8. Concentrations of inorganic and organic constituents in streambed- and suspended-sediment samples collected from sites on Leon Creek, San Antonio, Texas, 2012–14.—Continued

[QC, quality control; NWQL, U.S. Geological Survey National Water Quality Laboratory; SB, bottom material; SBQ, QC sample - bottom material; SS, suspended sediment; SSQ, QC sample - suspended sediment; --, no data; <, less than; E, estimated; M, presence verified but not quantified; b, value extrapolated at low end; h, compound identified and verified after additional review; m, value is highly variable by this method; n, below the reporting level but at or above the detection level; t, below the detection level; v, analyte detected in laboratory blank]

Site identifier (table 1)	Date	Medium code (QC sample type)	Cobalt (milligrams per kilogram)	Copper (milligrams per kilogram)	Gallium (milligrams per kilogram)	Iron (milligrams per kilogram)	Lead (milligrams per kilogram)	Lithium (milligrams per kilogram)
Loop 410	11/15/2012	SB	4	11	8	14,000	9	28
Loop 410	11/15/2012	SBQ (replicate)	4	12	8	13,000	10	27
Loop 410	01/09/2013	SS	Insufficient sediment	Insufficient sediment	Insufficient sediment	Insufficient sediment	Insufficient sediment	Insufficient sediment
Loop 410	02/07/2013	SB	4	12	8	14,000	11	19
Loop 410	02/07/2013	SBQ (replicate)	4	12	8	14,000	11	16
Loop 410	04/29/2013	SS	6	29	8	15,000	22	19
Loop 410	05/14/2013	SB	4	11	8	14,000	10	22
Loop 410	05/14/2013	SBQ (replicate)	4	11	8	14,000	11	21
Loop 410	05/24/2013	SS	4	14	8	13,000	16	23
Loop 410	06/25/2013	SB	6	14	11	20,000	15	30
Loop 410	06/25/2014	SS	6	17	10	18,000	23	32
Loop 410	07/22/2014	SB	3	12	8	12,000	15	26
Loop 410	07/22/2014	SBQ (replicate)	3	9	7	12,000	9	28
Rodriguez Park	11/15/2012	SB	7	17	10	19,000	20	23
Rodriguez Park	02/07/2013	SB	7	15	9	19,000	21	17
Rodriguez Park	04/29/2013	SS	10	24	12	22,000	20	23
Rodriguez Park	04/29/2013	SSQ (replicate)	10	16	10	21,000	21	22
Rodriguez Park	05/14/2013	SB	6	14	9	17,000	21	18
Rodriguez Park	05/24/2013	SS	6	17	9	17,000	21	25
Rodriguez Park	06/24/2013	SB	7	16	10	19,000	21	25
Rodriguez Park	06/25/2014	SS	9	20	13	23,000	24	30

72 Occurrence and Concentrations of Selected Trace Elements and Halogenated Organic Compounds in Stream Sediments

Table 8. Concentrations of inorganic and organic constituents in streambed- and suspended-sediment samples collected from sites on Leon Creek, San Antonio, Texas, 2012–14.—Continued

[QC, quality control; NWQL, U.S. Geological Survey National Water Quality Laboratory; SB, bottom material; SBQ, QC sample - bottom material; SS, suspended sediment; SSQ, QC sample - suspended sediment; --, no data; <, less than; E, estimated; M, presence verified but not quantified; b, value extrapolated at low end; h, compound identified and verified after additional review; m, value is highly variable by this method; n, below the reporting level but at or above the detection level; t, below the detection level; v, analyte detected in laboratory blank]

Site identifier (table 1)	Date	Medium code (QC sample type)	Cobalt (milligrams per kilogram)	Copper (milligrams per kilogram)	Gallium (milligrams per kilogram)	Iron (milligrams per kilogram)	Lead (milligrams per kilogram)	Lithium (milligrams per kilogram)
Rodriguez Park	07/21/2014	SB	7	16	10	18,000	22	24
Morey Road	11/15/2012	SB	9	21	11	25,000	20	26
Morey Road	01/09/2013	SS	Insufficient sediment	Insufficient sediment	Insufficient sediment	Insufficient sediment	Insufficient sediment	Insufficient sediment
Morey Road	02/06/2013	SB	7	14	10	22,000	17	18
Morey Road	02/06/2013	SBQ (replicate)	7	14	9	22,000	17	17
Morey Road	04/29/2013	SS	Insufficient sediment	Insufficient sediment	Insufficient sediment	Insufficient sediment	Insufficient sediment	Insufficient sediment
Morey Road	05/13/2013	SB	7	15	10	22,000	18	20
Morey Road	05/24/2013	SS	6	15	9	17,000	19	25
Morey Road	05/24/2013	SSQ (replicate)	6	16	10	18,000	19	26
Morey Road	06/25/2013	SB	9	15	10	22,000	16	26
Morey Road	06/25/2013	SBQ (replicate)	9	15	10	22,000	16	28
Morey Road	06/25/2014	SS	8	19	14	25,000	24	37
Morey Road	07/21/2014	SB	8	16	11	22,000	18	25
Joint Base	11/16/2012	SB	6	20	11	24,000	28	27
Joint Base	11/16/2012	SBQ (replicate)	6	20	11	24,000	28	27
Joint Base	02/06/2013	SB	6	18	10	23,000	26	20
Joint Base	05/13/2013	SB	5	17	10	21,000	31	22
Joint Base	06/24/2013	SB	6	19	12	24,000	33	34
Joint Base	07/21/2014	SB	6	18	11	21,000	28	26
--	11/28/2012	SBQ (standard reference material)	13	91	15	36,000	140	45
--	04/09/2013	SBQ (standard reference material)	13	87	14	38,000	140	38

Table 8. Concentrations of inorganic and organic constituents in streambed- and suspended-sediment samples collected from sites on Leon Creek, San Antonio, Texas, 2012–14.—Continued

[QC, quality control; NWQL, U.S. Geological Survey National Water Quality Laboratory; SB, bottom material; SBQ, QC sample - bottom material; SS, suspended sediment; SSQ, QC sample - suspended sediment; --, no data; <, less than; E, estimated; M, presence verified but not quantified; b, value extrapolated at low end; h, compound identified and verified after additional review; m, value is highly variable by this method; n, below the reporting level but at or above the detection level; t, below the detection level; v, analyte detected in laboratory blank]

Site identifier (table 1)	Date	Medium code (QC sample type)	Manganese (milligrams per kilogram)	Mercury (milligrams per kilogram)	Molybdenum (milligrams per kilogram)	Nickel (milligrams per kilogram)	Niobium (milligrams per kilogram)	Rubidium (milligrams per kilogram)
Loop 410	11/15/2012	SB	210	0.02	1.2	18	8	53.1
Loop 410	11/15/2012	SBQ (replicate)	200	0.02	1.1	17	8	51.2
Loop 410	01/09/2013	SS	Insufficient sediment	Insufficient sediment	Insufficient sediment	Insufficient sediment	Insufficient sediment	Insufficient sediment
Loop 410	02/07/2013	SB	250	0.01	1.0	5	7	48.4
Loop 410	02/07/2013	SBQ (replicate)	240	0.01	1.0	5	6	47.1
Loop 410	04/29/2013	SS	370	0.04	1.0	12	7	44.6
Loop 410	05/14/2013	SB	250	0.01	1.1	6	7	50.7
Loop 410	05/14/2013	SBQ (replicate)	260	0.01	1.0	5	7	49.6
Loop 410	05/24/2013	SS	310	0.02	M	6	7	45.1
Loop 410	06/25/2013	SB	420	0.01	1.0	14	7	64.7
Loop 410	06/25/2014	SS	370	Insufficient sediment	M	10	8	75.0
Loop 410	07/22/2014	SB	200	0.01	1.2	6	6	47.0
Loop 410	07/22/2014	SBQ (replicate)	190	0.01	1.2	5	6	46.0
Rodriguez Park	11/15/2012	SB	840	0.02	0.6	20	10	57.9
Rodriguez Park	02/07/2013	SB	1,200	0.02	0.6	9	8	54.4
Rodriguez Park	04/29/2013	SS	1,100	0.03	1.0	17	9	66.5
Rodriguez Park	04/29/2013	SSQ (replicate)	1,400	0.04	M	17	8	61.3
Rodriguez Park	05/14/2013	SB	760	0.03	0.7	9	8	53.6
Rodriguez Park	05/24/2013	SS	380	0.02	M	9	8	57.7
Rodriguez Park	06/24/2013	SB	920	0.02	0.7	11	8	58.3
Rodriguez Park	06/25/2014	SS	1,700	Insufficient sediment	M	15	8	72.3

74 Occurrence and Concentrations of Selected Trace Elements and Halogenated Organic Compounds in Stream Sediments

Table 8. Concentrations of inorganic and organic constituents in streambed- and suspended-sediment samples collected from sites on Leon Creek, San Antonio, Texas, 2012–14.—Continued

[QC, quality control; NWQL, U.S. Geological Survey National Water Quality Laboratory; SB, bottom material; SBQ, QC sample - bottom material; SS, suspended sediment; SSQ, QC sample - suspended sediment; --, no data; <, less than; E, estimated; M, presence verified but not quantified; b, value extrapolated at low end; h, compound identified and verified after additional review; m, value is highly variable by this method; n, below the reporting level but at or above the detection level; t, below the detection level; v, analyte detected in laboratory blank]

Site identifier (table 1)	Date	Medium code (QC sample type)	Manganese (milligrams per kilogram)	Mercury (milligrams per kilogram)	Molybdenum (milligrams per kilogram)	Nickel (milligrams per kilogram)	Niobium (milligrams per kilogram)	Rubidium (milligrams per kilogram)
Rodriguez Park	07/21/2014	SB	690	0.02	0.6	13	9	59.4
Morey Road	11/15/2012	SB	1,400	0.03	0.8	23	9	65.7
Morey Road	01/09/2013	SS	Insufficient sediment	Insufficient sediment	Insufficient sediment	Insufficient sediment	Insufficient sediment	Insufficient sediment
Morey Road	02/06/2013	SB	1,300	0.02	0.7	12	7	57.2
Morey Road	02/06/2013	SBQ (replicate)	1,200	0.02	0.7	12	7	56.5
Morey Road	04/29/2013	SS	Insufficient sediment	0.09	Insufficient sediment	Insufficient sediment	Insufficient sediment	Insufficient sediment
Morey Road	05/13/2013	SB	880	0.03	0.8	12	7	58.2
Morey Road	05/24/2013	SS	360	0.01	M	10	7	56.1
Morey Road	05/24/2013	SSQ (replicate)	340	0.02	M	11	7	59.9
Morey Road	06/25/2013	SB	1,600	0.01	0.7	13	7	63.1
Morey Road	06/25/2013	SBQ (replicate)	1,700	0.01	0.7	13	6	59.4
Morey Road	06/25/2014	SS	1,100	Insufficient sediment	M	17	9	78.6
Morey Road	07/21/2014	SB	800	0.02	0.8	14	8	64.7
Joint Base	11/16/2012	SB	310	0.03	0.7	20	10	65.4
Joint Base	11/16/2012	SBQ (replicate)	310	0.05	0.7	19	10	65.3
Joint Base	02/06/2013	SB	340	0.03	0.6	12	7	58.9
Joint Base	05/13/2013	SB	320	0.03	0.6	11	7	59.5
Joint Base	06/24/2013	SB	340	0.03	0.6	14	7	69.7
Joint Base	07/21/2014	SB	350	0.06	0.6	12	8	64.3
--	11/28/2012	SBQ (standard reference material)	530	0.71	3.7	42	13	95.2
--	04/09/2013	SBQ (standard reference material)	550	0.71	3.4	39	8	94.5

Table 8. Concentrations of inorganic and organic constituents in streambed- and suspended-sediment samples collected from sites on Leon Creek, San Antonio, Texas, 2012–14.—Continued

[QC, quality control; NWQL, U.S. Geological Survey National Water Quality Laboratory; SB, bottom material; SBQ, QC sample - bottom material; SS, suspended sediment; SSQ, QC sample - suspended sediment; --, no data; <, less than; E, estimated; M, presence verified but not quantified; b, value extrapolated at low end; h, compound identified and verified after additional review; m, value is highly variable by this method; n, below the reporting level but at or above the detection level; t, below the detection level; v, analyte detected in laboratory blank]

Site identifier (table 1)	Date	Medium code (QC sample type)	Scandium (milligrams per kilogram)	Silver (milligrams per kilogram)	Strontium (milligrams per kilogram)	Thallium (milligrams per kilogram)	Titanium (milligrams per kilogram)	Vanadium (milligrams per kilogram)
Loop 410	11/15/2012	SB	5	0.1	380	0.39	1,900	60
Loop 410	11/15/2012	SBQ (replicate)	5	0.1	370	0.35	1,800	57
Loop 410	01/09/2013	SS	Insufficient sediment	Insufficient sediment	Insufficient sediment	Insufficient sediment	Insufficient sediment	Insufficient sediment
Loop 410	02/07/2013	SB	5	0.2	310	0.34	1,700	53
Loop 410	02/07/2013	SBQ (replicate)	4	0.2	320	0.36	1,600	52
Loop 410	04/29/2013	SS	5	<1	310	0.40	1,400	43
Loop 410	05/14/2013	SB	5	0.2	320	0.36	1,700	56
Loop 410	05/14/2013	SBQ (replicate)	5	0.2	340	0.36	1,600	56
Loop 410	05/24/2013	SS	5	<0.01	280	0.40	1,600	48
Loop 410	06/25/2013	SB	6	0.2	310	0.58	2,200	72
Loop 410	06/25/2014	SS	5	<0.02	240	0.60	1,800	59
Loop 410	07/22/2014	SB	5	<0.02	430	0.31	1,600	61
Loop 410	07/22/2014	SBQ (replicate)	4	<0.02	440	0.32	1,600	58
Rodriguez Park	11/15/2012	SB	6	0.1	180	0.44	2,300	55
Rodriguez Park	02/07/2013	SB	6	0.2	170	0.42	2,200	51
Rodriguez Park	04/29/2013	SS	7	<1	180	0.50	1,900	54
Rodriguez Park	04/29/2013	SSQ (replicate)	7	<1	180	0.50	1,800	52
Rodriguez Park	05/14/2013	SB	6	0.2	170	0.42	1,900	50
Rodriguez Park	05/24/2013	SS	6	<0.01	190	0.40	2,000	54
Rodriguez Park	06/24/2013	SB	6	0.2	180	0.44	2,000	52
Rodriguez Park	06/25/2014	SS	6	<0.02	190	0.60	2,100	69

76 Occurrence and Concentrations of Selected Trace Elements and Halogenated Organic Compounds in Stream Sediments

Table 8. Concentrations of inorganic and organic constituents in streambed- and suspended-sediment samples collected from sites on Leon Creek, San Antonio, Texas, 2012–14.—Continued

[QC, quality control; NWQL, U.S. Geological Survey National Water Quality Laboratory; SB, bottom material; SBQ, QC sample - bottom material; SS, suspended sediment; SSQ, QC sample - suspended sediment; --, no data; <, less than; E, estimated; M, presence verified but not quantified; b, value extrapolated at low end; h, compound identified and verified after additional review; m, value is highly variable by this method; n, below the reporting level but at or above the detection level; t, below the detection level; v, analyte detected in laboratory blank]

Site identifier (table 1)	Date	Medium code (QC sample type)	Scandium (milligrams per kilogram)	Silver (milligrams per kilogram)	Strontium (milligrams per kilogram)	Thallium (milligrams per kilogram)	Titanium (milligrams per kilogram)	Vanadium (milligrams per kilogram)
Rodriguez Park	07/21/2014	SB	6	<0.02	170	0.47	2,200	57
Morey Road	11/15/2012	SB	7	0.1	160	0.49	2,400	74
Morey Road	01/09/2013	SS	Insufficient sediment	Insufficient sediment	Insufficient sediment	Insufficient sediment	Insufficient sediment	Insufficient sediment
Morey Road	02/06/2013	SB	6	0.2	160	0.45	2,000	63
Morey Road	02/06/2013	SBQ (replicate)	6	0.2	160	0.43	2,000	61
Morey Road	04/29/2013	SS	Insufficient sediment	Insufficient sediment	Insufficient sediment	Insufficient sediment	Insufficient sediment	Insufficient sediment
Morey Road	05/13/2013	SB	6	0.2	160	0.44	1,900	63
Morey Road	05/24/2013	SS	6	<0.01	180	0.40	2,000	60
Morey Road	05/24/2013	SSQ (replicate)	6	<0.01	180	0.40	2,200	66
Morey Road	06/25/2013	SB	7	0.1	160	0.44	2,000	66
Morey Road	06/25/2013	SBQ (replicate)	6	0.1	160	0.45	1,700	61
Morey Road	06/25/2014	SS	7	<0.02	190	0.60	2,400	82
Morey Road	07/21/2014	SB	7	<0.02	180	0.47	2,200	69
Joint Base	11/16/2012	SB	7	0.3	150	0.44	2,600	77
Joint Base	11/16/2012	SBQ (replicate)	7	0.3	150	0.45	2,600	76
Joint Base	02/06/2013	SB	6	0.3	150	0.41	2,000	68
Joint Base	05/13/2013	SB	6	0.4	150	0.42	2,000	67
Joint Base	06/24/2013	SB	7	0.3	160	0.46	2,200	76
Joint Base	07/21/2014	SB	7	0.1	160	0.43	2,200	72
--	11/28/2012	SBQ (standard reference material)	11	0.4	130	1.1	3,900	90
--	04/09/2013	SBQ (standard reference material)	10	0.6	120	1.0	3,400	86

Table 8. Concentrations of inorganic and organic constituents in streambed- and suspended-sediment samples collected from sites on Leon Creek, San Antonio, Texas, 2012–14.—Continued

[QC, quality control; NWQL, U.S. Geological Survey National Water Quality Laboratory; SB, bottom material; SBQ, QC sample - bottom material; SS, suspended sediment; SSQ, QC sample - suspended sediment; --, no data; <, less than; E, estimated; M, presence verified but not quantified; b, value extrapolated at low end; h, compound identified and verified after additional review; m, value is highly variable by this method; n, below the reporting level but at or above the detection level; t, below the detection level; v, analyte detected in laboratory blank]

Site identifier (table 1)	Date	Medium code (QC sample type)	Zinc (milligrams per kilogram)	Antimony (milligrams per kilogram)	Arsenic (milligrams per kilogram)	alpha-Endosulfan (micrograms per kilogram)	Benfluralin (micrograms per kilogram)	beta-Endosulfan (micrograms per kilogram)
Loop 410	11/15/2012	SB	61	0.7	5.3	<0.20	<0.20	<0.20
Loop 410	11/15/2012	SBQ (replicate)	57	0.7	5.2	<0.20	<0.20	<0.20
Loop 410	01/09/2013	SS	Insufficient sediment	Insufficient sediment	Insufficient sediment	<0.20	<0.20	<0.20
Loop 410	02/07/2013	SB	58	0.6	5.0	<0.20	<0.20	<0.20
Loop 410	02/07/2013	SBQ (replicate)	55	0.6	4.8	<0.20	<0.20	<0.20
Loop 410	04/29/2013	SS	140	1.4	8.0	<0.20	<0.20	<0.20
Loop 410	05/14/2013	SB	58	0.7	5.4	<0.20	<0.20	<0.20
Loop 410	05/14/2013	SBQ (replicate)	58	0.6	5.8	<0.20	<0.20	<0.20
Loop 410	05/24/2013	SS	62	0.8	6.9	<0.20	<0.20	<0.20
Loop 410	06/25/2013	SB	75	0.8	9.0	<0.20	<0.20	<0.20
Loop 410	06/25/2014	SS	110	1.1	8.6	<0.20	<0.20	<0.20
Loop 410	07/22/2014	SB	160	0.6	5.2	<0.20	<0.20	<0.20
Loop 410	07/22/2014	SBQ (replicate)	56	0.5	5.2	<0.20	<0.20	<0.20
Rodriguez Park	11/15/2012	SB	68	0.7	7.5	<0.20	<0.20	<0.20
Rodriguez Park	02/07/2013	SB	68	0.7	7.3	<0.20	<0.20	<0.20
Rodriguez Park	04/29/2013	SS	92	1.0	11	<0.20	<0.20	<0.20
Rodriguez Park	04/29/2013	SSQ (replicate)	81	1.0	10	<0.20	<0.20	<0.20
Rodriguez Park	05/14/2013	SB	66	0.7	6.8	<0.20	<0.20	<0.20
Rodriguez Park	05/24/2013	SS	76	0.8	7.4	<0.20	<0.20	<0.20
Rodriguez Park	06/24/2013	SB	76	0.8	9.0	<0.20	<0.20	<0.20
Rodriguez Park	06/25/2014	SS	140	1.1	13	0.07 t	<0.20	<0.20

78 Occurrence and Concentrations of Selected Trace Elements and Halogenated Organic Compounds in Stream Sediments

Table 8. Concentrations of inorganic and organic constituents in streambed- and suspended-sediment samples collected from sites on Leon Creek, San Antonio, Texas, 2012–14.—Continued

[QC, quality control; NWQL, U.S. Geological Survey National Water Quality Laboratory; SB, bottom material; SBQ, QC sample - bottom material; SS, suspended sediment; SSQ, QC sample - suspended sediment; --, no data; <, less than; E, estimated; M, presence verified but not quantified; b, value extrapolated at low end; h, compound identified and verified after additional review; m, value is highly variable by this method; n, below the reporting level but at or above the detection level; t, below the detection level; v, analyte detected in laboratory blank]

Site identifier (table 1)	Date	Medium code (QC sample type)	Zinc (milligrams per kilogram)	Antimony (milligrams per kilogram)	Arsenic (milligrams per kilogram)	alpha-Endosulfan (micrograms per kilogram)	Benfluralin (micrograms per kilogram)	beta-Endosulfan (micrograms per kilogram)
Rodriguez Park	07/21/2014	SB	100	0.7	7.0	<0.20	<0.20	<0.20
Morey Road	11/15/2012	SB	92	0.7	11	<0.20	<0.20	<0.20
Morey Road	01/09/2013	SS	Insufficient sediment	Insufficient sediment	Insufficient sediment	Insufficient sediment	Insufficient sediment	Insufficient sediment
Morey Road	02/06/2013	SB	73	0.6	7.4	<0.20	<0.20	<0.20
Morey Road	02/06/2013	SBQ (replicate)	71	0.6	7.3	<0.20	<0.20	<0.20
Morey Road	04/29/2013	SS	Insufficient sediment	Insufficient sediment	Insufficient sediment	<0.20	<0.20	<0.20
Morey Road	05/13/2013	SB	82	0.7	8.1	<0.20	<0.20	<0.20
Morey Road	05/24/2013	SS	72	0.7	6.4	<0.20	<0.20	<0.20
Morey Road	05/24/2013	SSQ (replicate)	72	0.6	6.5	<0.20	<0.20	<0.20
Morey Road	06/25/2013	SB	81	0.6	12	<0.20	<0.20	<0.20
Morey Road	06/25/2013	SBQ (replicate)	79	0.5	13	<0.20	<0.20	<0.20
Morey Road	06/25/2014	SS	140	1.1	11	<0.20	<0.20	<0.20
Morey Road	07/21/2014	SB	85	0.7	8.3	<0.20	<0.20	<0.20
Joint Base	11/16/2012	SB	99	0.9	6.2	<0.20	<0.20	<0.20
Joint Base	11/16/2012	SBQ (replicate)	98	0.9	6.1	<0.20	<0.20	<0.20
Joint Base	02/06/2013	SB	88	0.7	5.8	<0.20	<0.20	<0.20
Joint Base	05/13/2013	SB	91	0.9	5.6	<0.20	<0.20	<0.20
Joint Base	06/24/2013	SB	110	0.8	6.5	<0.20	<0.20	<0.20
Joint Base	07/21/2014	SB	100	0.8	6.1	<0.20	<0.20	<0.20
--	11/28/2012	SBQ (standard reference material)	380	2.8	16	<0.20	<0.20	<0.20
--	04/09/2013	SBQ (standard reference material)	380	2.6	15	<0.20	<0.20	<0.20

Table 8. Concentrations of inorganic and organic constituents in streambed- and suspended-sediment samples collected from sites on Leon Creek, San Antonio, Texas, 2012–14.—Continued

[QC, quality control; NWQL, U.S. Geological Survey National Water Quality Laboratory; SB, bottom material; SBQ, QC sample - bottom material; SS, suspended sediment; SSQ, QC sample - suspended sediment; --, no data; <, less than; E, estimated; M, presence verified but not quantified; b, value extrapolated at low end; h, compound identified and verified after additional review; m, value is highly variable by this method; n, below the reporting level but at or above the detection level; t, below the detection level; v, analyte detected in laboratory blank]

Site identifier (table 1)	Date	Medium code (QC sample type)	Chlorpyrifos (micrograms per kilogram)	<i>cis</i> -Chlordane (micrograms per kilogram)	<i>cis</i> -Nonachlor (micrograms per kilogram)	Cyfluthrin (micrograms per kilogram)	DCPA (Dacthal) (micrograms per kilogram)	Desulfinyl-fipronil (micrograms per kilogram)
Loop 410	11/15/2012	SB	<0.20	<0.20	<0.10	<0.20 m	<0.20	0.10
Loop 410	11/15/2012	SBQ (replicate)	<0.20	<0.20	<0.10	<0.20 m	<0.20	<0.10
Loop 410	01/09/2013	SS	<0.20	0.37	0.13	E16.0 m	0.07 t	E0.08 n
Loop 410	02/07/2013	SB	<0.20	<0.20	<0.10	<0.20 m	<0.20	E0.01 bt
Loop 410	02/07/2013	SBQ (replicate)	<0.20	0.01 bt	<0.10	<0.20 m	<0.20	<0.10
Loop 410	04/29/2013	SS	E5.5	0.43	E0.14	E7.6 m	<0.20	E0.15
Loop 410	05/14/2013	SB	<0.20	0.06 t	<0.10	E0.07 bmt	<0.20	E0.02 bt
Loop 410	05/14/2013	SBQ (replicate)	<0.20	E0.08 tm	E0.04 bt	E2.9 m	<0.20	E0.95
Loop 410	05/24/2013	SS	E2.3	E0.47	E0.24	E15.7 m	<0.20	E1.0
Loop 410	06/25/2013	SB	<0.20	E0.02 btm	<0.10	E0.08 bmt	<0.20	<0.10
Loop 410	06/25/2014	SS	E0.07 tm	0.31	0.14	E1.6 m	<0.20	0.10
Loop 410	07/22/2014	SB	<0.20	<0.20	<0.10	<0.20 m	<0.20	<0.10
Loop 410	07/22/2014	SBQ (replicate)	<0.20	<0.20	<0.10	<0.20 m	<0.20	<0.10
Rodriguez Park	11/15/2012	SB	<0.20	0.26	<0.10	<0.20 m	<0.20	<0.10
Rodriguez Park	02/07/2013	SB	<0.20	0.18 n	0.06 t	<0.20 m	<0.20	<0.10
Rodriguez Park	04/29/2013	SS	<0.20	0.44	E0.09 n	E13.4 m	<0.20	E0.08 n
Rodriguez Park	04/29/2013	SSQ (replicate)	<0.20	0.60	E0.12	E11.9 m	<0.20	E0.07 n
Rodriguez Park	05/14/2013	SB	<0.20	E0.33	E0.13	E1.3 m	<0.20	<0.17
Rodriguez Park	05/24/2013	SS	E1.5	E1.0	E0.56	E25.4 m	<0.20	E1.1
Rodriguez Park	06/24/2013	SB	<0.20	0.38	E0.07 n	E0.04 bmt	<0.20	<0.10
Rodriguez Park	06/25/2014	SS	<0.20	0.58	0.28	E1.6 m	<0.20	<0.15

80 Occurrence and Concentrations of Selected Trace Elements and Halogenated Organic Compounds in Stream Sediments
Table 8. Concentrations of inorganic and organic constituents in streambed- and suspended-sediment samples collected from sites on Leon Creek, San Antonio, Texas, 2012–14.—Continued

[QC, quality control; NWQL, U.S. Geological Survey National Water Quality Laboratory; SB, bottom material; SBQ, QC sample - bottom material; SS, suspended sediment; SSQ, QC sample - suspended sediment; --, no data; <, less than; E, estimated; M, presence verified but not quantified; b, value extrapolated at low end; h, compound identified and verified after additional review; m, value is highly variable by this method; n, below the reporting level but at or above the detection level; t, below the detection level; v, analyte detected in laboratory blank]

Site identifier (table 1)	Date	Medium code (QC sample type)	Chlorpyrifos (micrograms per kilogram)	<i>cis</i> -Chlordane (micrograms per kilogram)	<i>cis</i> -Nonachlor (micrograms per kilogram)	Cyfluthrin (micrograms per kilogram)	DCPA (Dacthal) (micrograms per kilogram)	Desulfinyl-fipronil (micrograms per kilogram)
Rodriguez Park	07/21/2014	SB	<0.20	0.38	0.12	<0.20 m	<0.20	0.03 bt
Morey Road	11/15/2012	SB	<0.20	<0.20	<0.10	<0.20 m	<0.20	<0.10
Morey Road	01/09/2013	SS	Insufficient sediment	Insufficient sediment	Insufficient sediment	Insufficient sediment	Insufficient sediment	Insufficient sediment
Morey Road	02/06/2013	SB	<0.20	0.03 bt	0.01 bt	<0.20 m	<0.20	<0.10
Morey Road	02/06/2013	SBQ (replicate)	<0.20	0.05 t	E0.02 bt	<0.20 m	<0.20	<0.10
Morey Road	04/29/2013	SS	<0.20	1.6	E0.55	E1.4 m	<0.20	<0.10
Morey Road	05/13/2013	SB	<0.20	E0.05 tm	E0.04 bt	<2.0 m	<0.20	E0.06 t
Morey Road	05/24/2013	SS	E2.2	E0.69	E0.30	E12.7 m	<0.20	<0.34
Morey Road	05/24/2013	SSQ (replicate)	E1.3	0.75	E0.30	E11.9 m	<0.20	E0.62
Morey Road	06/25/2013	SB	<0.20	0.27	E0.21	E2.0 m	<0.20	<0.10
Morey Road	06/25/2013	SBQ (replicate)	<0.20	0.08 n	E0.04 bt	<2.0 m	<0.20	E0.07 n
Morey Road	06/25/2014	SS	<0.20	0.32	0.10 n	E1.5 m	<0.20	<0.28
Morey Road	07/21/2014	SB	<0.20	3.1	0.48	<0.20 m	<0.20	<0.10
Joint Base	11/16/2012	SB	<0.20	1.2	0.36	<0.55 m	<0.20	0.11
Joint Base	11/16/2012	SBQ (replicate)	<0.20	0.57	0.17	<0.20 m	<0.20	<0.10
Joint Base	02/06/2013	SB	<0.20	0.53	0.15	<0.20 m	<0.20	<0.10
Joint Base	05/13/2013	SB	<0.20	1.3	E0.49	E0.22 m	<0.20	<0.10
Joint Base	06/24/2013	SB	<0.20	2.6	E1.1	<2.0 m	<0.20	E0.30
Joint Base	07/21/2014	SB	<0.20	2.0	0.34	<0.20 m	<0.20	0.02 bt
--	11/28/2012	SBQ (standard reference material)	<0.20	<0.20	<0.10	<0.20 m	<0.20	<0.10
--	04/09/2013	SBQ (standard reference material)	<0.20	0.04 t	E0.03 bt	<0.20 m	<0.20	<0.10

Table 8. Concentrations of inorganic and organic constituents in streambed- and suspended-sediment samples collected from sites on Leon Creek, San Antonio, Texas, 2012–14.—Continued

[QC, quality control; NWQL, U.S. Geological Survey National Water Quality Laboratory; SB, bottom material; SBQ, QC sample - bottom material; SS, suspended sediment; SSQ, QC sample - suspended sediment; --, no data; <, less than; E, estimated; M, presence verified but not quantified; b, value extrapolated at low end; h, compound identified and verified after additional review; m, value is highly variable by this method; n, below the reporting level but at or above the detection level; t, below the detection level; v, analyte detected in laboratory blank]

Site identifier (table 1)	Date	Medium code (QC sample type)	Dieldrin (micrograms per kilogram)	Endosulfan sulfate (micrograms per kilogram)	Fipronil sulfide (micrograms per kilogram)	Fipronil (micrograms per kilogram)	Hexachlorobenzene (micrograms per kilogram)	lambda-Cyhalothrin (micrograms per kilogram)
Loop 410	11/15/2012	SB	<0.10	<0.40	<0.10	--	<0.10	<0.20
Loop 410	11/15/2012	SBQ (replicate)	<0.10	<0.40	<0.10	--	<0.10	1.7
Loop 410	01/09/2013	SS	<0.10	<0.40	<0.10	--	0.22	E2.9
Loop 410	02/07/2013	SB	<0.10	<0.40	<0.10	--	<0.10	<0.20
Loop 410	02/07/2013	SBQ (replicate)	<0.10	<0.40	<0.10	--	<0.10	<0.20
Loop 410	04/29/2013	SS	<0.10	<0.40	E0.04 bt	--	<0.10	E1.9
Loop 410	05/14/2013	SB	<0.10	<0.40	E0.02 bt	--	<0.10	<0.20
Loop 410	05/14/2013	SBQ (replicate)	<0.10	<0.40	E0.05 t	--	<0.10	<0.20
Loop 410	05/24/2013	SS	E0.11	<0.40	E0.08 n	--	<0.10	E4.5
Loop 410	06/25/2013	SB	<0.10	<0.40	<0.10	--	<0.10	<0.20
Loop 410	06/25/2014	SS	E0.21	<0.40	<0.10	<0.10 m	<38	1.1
Loop 410	07/22/2014	SB	<0.10	<0.40	<0.10	<0.10 m	<0.10	<0.20
Loop 410	07/22/2014	SBQ (replicate)	<0.10	<0.40	<0.10	<0.10 m	<0.10	<0.20
Rodriguez Park	11/15/2012	SB	E0.15	<0.40	<0.10	--	<0.10	<0.20
Rodriguez Park	02/07/2013	SB	E0.06 t	<0.40	E0.01 b	--	<0.10	<0.20
Rodriguez Park	04/29/2013	SS	<0.10	<0.40	E0.05 t	--	<0.10	E2.1
Rodriguez Park	04/29/2013	SSQ (replicate)	<0.10	<0.40	E0.04 t	--	<0.10	E2.6
Rodriguez Park	05/14/2013	SB	E0.26	<0.40	E0.02 bt	--	<0.10	<0.20
Rodriguez Park	05/24/2013	SS	E0.44	<0.40	0.09 n	<0.10 m	<0.10	E8.2
Rodriguez Park	06/24/2013	SB	E0.21	<0.40	<0.10	--	<0.10	<0.20
Rodriguez Park	06/25/2014	SS	E0.47	<0.40	<0.10	<0.10 m	<110	0.43

82 Occurrence and Concentrations of Selected Trace Elements and Halogenated Organic Compounds in Stream Sediments
Table 8. Concentrations of inorganic and organic constituents in streambed- and suspended-sediment samples collected from sites on Leon Creek, San Antonio, Texas, 2012–14.—Continued

[QC, quality control; NWQL, U.S. Geological Survey National Water Quality Laboratory; SB, bottom material; SBQ, QC sample - bottom material; SS, suspended sediment; SSQ, QC sample - suspended sediment; --, no data; <, less than; E, estimated; M, presence verified but not quantified; b, value extrapolated at low end; h, compound identified and verified after additional review; m, value is highly variable by this method; n, below the reporting level but at or above the detection level; t, below the detection level; v, analyte detected in laboratory blank]

Site identifier (table 1)	Date	Medium code (QC sample type)	Dieldrin (micrograms per kilogram)	Endosulfan sulfate (micrograms per kilogram)	Fipronil sulfide (micrograms per kilogram)	Fipronil (micrograms per kilogram)	Hexachloro-benzene (micrograms per kilogram)	lambda-Cyhalothrin (micrograms per kilogram)
Rodriguez Park	07/21/2014	SB	0.11	<0.40	0.01 bt	<0.42 vm	<0.10	<0.20
Morey Road	11/15/2012	SB	<0.10	<0.40	<0.10	--	<0.10	<0.20
Morey Road	01/09/2013	SS	Insufficient sediment	Insufficient sediment	Insufficient sediment	Insufficient sediment	Insufficient sediment	Insufficient sediment
Morey Road	02/06/2013	SB	<0.10	<0.40	<0.10	--	<0.10	<0.20
Morey Road	02/06/2013	SBQ (replicate)	<0.10	<0.40	<0.10	--	<0.10	<0.20
Morey Road	04/29/2013	SS	<0.10	<0.40	<0.10	--	<0.10	E0.10 t
Morey Road	05/13/2013	SB	<0.10	<0.40	E0.01 b	--	<0.10	<0.20
Morey Road	05/24/2013	SS	E0.28	<0.40	<0.10	--	<0.10	E3.2
Morey Road	05/24/2013	SSQ (replicate)	E0.46	<0.40	E0.14	E6.9 m	<0.10	E3.4
Morey Road	06/25/2013	SB	E0.01 bt	<0.40	E0.01 bt	--	<0.10	<0.20
Morey Road	06/25/2013	SBQ (replicate)	E0.01 bt	<0.40	E0.01 bt	--	<0.10	<0.20
Morey Road	06/25/2014	SS	<0.10	<0.40	<0.16	<0.10 m	<160	0.43
Morey Road	07/21/2014	SB	<0.10	<0.40	<0.10	<0.41 vm	<0.10	<0.20
Joint Base	11/16/2012	SB	0.13	<0.40	<0.10	--	<0.10	<0.20
Joint Base	11/16/2012	SBQ (replicate)	<0.10	<0.40	<0.10	--	<0.10	<0.20
Joint Base	02/06/2013	SB	<0.10	<0.40	<0.10	--	<0.10	<0.20
Joint Base	05/13/2013	SB	<0.10	<0.40	E0.03 bt	--	<0.10	E0.21
Joint Base	06/24/2013	SB	E0.10 n	<0.40	E0.05 t	--	<0.10	<0.20
Joint Base	07/21/2014	SB	<0.10	<0.40	0.02 bt	<0.42 vm	<0.98	<0.20
--	11/28/2012	SBQ (standard reference material)	<0.10	<0.40	<0.10	--	6.5	<0.20
--	04/09/2013	SBQ (standard reference material)	<0.10	<0.40	<0.10	--	2.9	<0.20

Table 8. Concentrations of inorganic and organic constituents in streambed- and suspended-sediment samples collected from sites on Leon Creek, San Antonio, Texas, 2012–14.—Continued

[QC, quality control; NWQL, U.S. Geological Survey National Water Quality Laboratory; SB, bottom material; SBQ, QC sample - bottom material; SS, suspended sediment; SSQ, QC sample - suspended sediment; --, no data; <, less than; E, estimated; M, presence verified but not quantified; b, value extrapolated at low end; h, compound identified and verified after additional review; m, value is highly variable by this method; n, below the reporting level but at or above the detection level; t, below the detection level; v, analyte detected in laboratory blank]

Site identifier (table 1)	Date	Medium code (QC sample type)	Oxychlorthane (micrograms per kilogram)	Oxyfluorfen (micrograms per kilogram)	<i>p,p'</i> -DDD (micrograms per kilogram)	<i>p,p'</i> -DDE (micrograms per kilogram)	<i>p,p'</i> -DDT (micrograms per kilogram)	Pendi-methalin (micrograms per kilogram)
Loop 410	11/15/2012	SB	<1.0	<4.0	<2.0	<1.0	<4.0	<1.0
Loop 410	11/15/2012	SBQ (replicate)	<1.0	<4.0	<2.0	<1.0	<4.0	<1.0
Loop 410	01/09/2013	SS	<1.0	<4.0	<2.0	<1.0	<4.0	<1.0
Loop 410	02/07/2013	SB	<1.0	<4.0	<2.0	<1.0	<4.0	<1.0
Loop 410	02/07/2013	SBQ (replicate)	<1.0	<4.0	<2.0	<1.0	<4.0	<1.0
Loop 410	04/29/2013	SS	<1.0	<4.0	<2.0	<1.0	<4.0	<1.0
Loop 410	05/14/2013	SB	<1.0	<4.0	<2.0	<1.0	<4.0	<1.0
Loop 410	05/14/2013	SBQ (replicate)	<1.0	<4.0	<2.0 h	<1.0 h	<4.0 h	<1.0
Loop 410	05/24/2013	SS	<1.0	<4.0	<2.0 h	<1.0 h	<4.0 h	<1.0
Loop 410	06/25/2013	SB	<1.0	<4.0	<2.0	<1.0	<4.0	<1.0
Loop 410	06/25/2014	SS	<1.0	<4.0	<2.0	<1.0	<4.0	<1.0
Loop 410	07/22/2014	SB	<1.0	<4.0	<2.0	<1.0	<4.0	<1.0
Loop 410	07/22/2014	SBQ (replicate)	<1.0	<4.0	<2.0	<1.0	<4.0	<1.0
Rodriguez Park	11/15/2012	SB	<1.0	<4.0	<2.0	<1.0	<4.0	<1.0
Rodriguez Park	02/07/2013	SB	<1.0	<4.0	<2.0	0.65 n	<4.0	<1.0
Rodriguez Park	04/29/2013	SS	<1.0	<4.0	<2.0	<1.0	<4.0	<1.0
Rodriguez Park	04/29/2013	SSQ (replicate)	<1.0	<4.0	<2.0	<1.0	<4.0	<1.0
Rodriguez Park	05/14/2013	SB	<1.0	<4.0	<2.0 h	E0.02 b	E1.5 t	<1.0
Rodriguez Park	05/24/2013	SS	<1.0	<4.0	<2.0 h	0.13 bt	<4.0 h	--
Rodriguez Park	06/24/2013	SB	<1.0	<4.0	<2.0	E0.51 n	E0.38 bt	<1.0
Rodriguez Park	06/25/2014	SS	<1.0	<4.0	<2.0	<1.0	<4.0	<1.0

84 Occurrence and Concentrations of Selected Trace Elements and Halogenated Organic Compounds in Stream Sediments
Table 8. Concentrations of inorganic and organic constituents in streambed- and suspended-sediment samples collected from sites on Leon Creek, San Antonio, Texas, 2012–14.—Continued

[QC, quality control; NWQL, U.S. Geological Survey National Water Quality Laboratory; SB, bottom material; SBQ, QC sample - bottom material; SS, suspended sediment; SSQ, QC sample - suspended sediment; --, no data; <, less than; E, estimated; M, presence verified but not quantified; b, value extrapolated at low end; h, compound identified and verified after additional review; m, value is highly variable by this method; n, below the reporting level but at or above the detection level; t, below the detection level; v, analyte detected in laboratory blank]

Site identifier (table 1)	Date	Medium code (QC sample type)	Oxychlorthane (micrograms per kilogram)	Oxyfluorfen (micrograms per kilogram)	<i>p,p'</i> -DDD (micrograms per kilogram)	<i>p,p'</i> -DDE (micrograms per kilogram)	<i>p,p'</i> -DDT (micrograms per kilogram)	Pendi-methalin (micrograms per kilogram)
Rodriguez Park	07/21/2014	SB	<1.0	<4.0	<2.0	<1.0	<4.0	<1.0
Morey Road	11/15/2012	SB	<1.0	<4.0	<2.0	0.63 n	<4.0	<1.0
Morey Road	01/09/2013	SS	Insufficient sediment	Insufficient sediment	Insufficient sediment	Insufficient sediment	Insufficient sediment	Insufficient sediment
Morey Road	02/06/2013	SB	<1.0	<4.0	<2.0	2.2	<4.0	<1.0
Morey Road	02/06/2013	SBQ (replicate)	<1.0	<4.0	<2.0	1.2	<4.0	<1.0
Morey Road	04/29/2013	SS	<1.0	<4.0	<2.0	2.6	<4.0	<1.0
Morey Road	05/13/2013	SB	<1.0	<4.0	<2.0 h	E0.60 n	E2.6 n	<1.0
Morey Road	05/24/2013	SS	<1.0	<4.0	<2.0 h	E0.28 bt	<4.0	<1.0
Morey Road	05/24/2013	SSQ (replicate)	<1.0	<4.0	<2.0 h	E0.22 bt	E35.8	<1.0
Morey Road	06/25/2013	SB	<1.0	<4.0	<2.0 h	E0.12 bt	E1.5 t	<1.0
Morey Road	06/25/2013	SBQ (replicate)	<1.0	<4.0	<2.0 h	E0.31 bn	E4.7	<1.0
Morey Road	06/25/2014	SS	<1.0	<4.0	<2.0	<1.0	<4.0	<1.0
Morey Road	07/21/2014	SB	<1.0	<4.0	0.39 bt	<1.0	<4.0	<1.0
Joint Base	11/16/2012	SB	<1.0	<4.0	9.6	13.7	<4.0	<1.0
Joint Base	11/16/2012	SBQ (replicate)	<1.0	<4.0	6.2	5.8	<4.0	<1.0
Joint Base	02/06/2013	SB	<1.0	<4.0	<2.0	9.6	<4.0	<1.0
Joint Base	05/13/2013	SB	<1.0	<4.0	<2.0	20.8	E118	<1.0
Joint Base	06/24/2013	SB	<1.0	<4.0	E58.3	E10.4	E130	<1.0
Joint Base	07/21/2014	SB	<1.0	<4.0	4.4	19.0	2.9 n	<1.0
--	11/28/2012	SBQ (standard reference material)	<1.0	<4.0	<2.0	<1.0	<4.0	<1.0
--	04/09/2013	SBQ (standard reference material)	<1.0	<4.0	<2.0	0.14 bt	<4.0	<1.0

Table 8. Concentrations of inorganic and organic constituents in streambed- and suspended-sediment samples collected from sites on Leon Creek, San Antonio, Texas, 2012–14.—Continued

[QC, quality control; NWQL, U.S. Geological Survey National Water Quality Laboratory; SB, bottom material; SBQ, QC sample - bottom material; SS, suspended sediment; SSQ, QC sample - suspended sediment; --, no data; <, less than; E, estimated; M, presence verified but not quantified; b, value extrapolated at low end; h, compound identified and verified after additional review; m, value is highly variable by this method; n, below the reporting level but at or above the detection level; t, below the detection level; v, analyte detected in laboratory blank]

Site identifier (table 1)	Date	Medium code (QC sample type)	Pentachloro-anisole (micrograms per kilogram)	Pentachloro-nitrobenzene (micrograms per kilogram)	Tefluthrin (micrograms per kilogram)	Tetradifon (micrograms per kilogram)	<i>trans</i> -Chlordane (micrograms per kilogram)	<i>trans</i> -Nonachlor (micrograms per kilogram)
Loop 410	11/15/2012	SB	<0.10	<0.10	<0.50	<0.20	<0.20	<0.10
Loop 410	11/15/2012	SBQ (replicate)	<0.10	<0.10	<0.50	<0.20	<0.20	<0.10
Loop 410	01/09/2013	SS	0.12	<0.10	<0.50	<0.20	0.18 n	0.32
Loop 410	02/07/2013	SB	<0.10	<0.10	<0.50	<0.20	<0.20	<0.10
Loop 410	02/07/2013	SBQ (replicate)	<0.10	<0.10	<0.50	<0.20	<0.20	<0.10
Loop 410	04/29/2013	SS	<0.10	<0.10	<0.50	<0.20	E0.36	E0.52
Loop 410	05/14/2013	SB	<0.10	<0.10	<0.50	<0.20	<0.20	M
Loop 410	05/14/2013	SBQ (replicate)	0.01 bt	<0.10	<0.50	<0.20	E0.03 bt	E0.11
Loop 410	05/24/2013	SS	0.03 bt	<0.10	<0.50	<0.20	E0.25	E0.58
Loop 410	06/25/2013	SB	<0.10	<0.10	<0.50	<0.20	<0.20	E0.03 bt
Loop 410	06/25/2014	SS	<38	<38	<0.50	<0.20	0.20	0.33
Loop 410	07/22/2014	SB	<0.10	<0.10	E0.04 t	<0.20	E0.10 n	E0.10 n
Loop 410	07/22/2014	SBQ (replicate)	<0.10	<0.10	<0.50	<0.20	<0.20	<0.10
Rodriguez Park	11/15/2012	SB	<0.10	<0.10	<0.50	<0.20	0.25	0.18
Rodriguez Park	02/07/2013	SB	<0.10	<0.10	<0.50	<0.20	0.23	0.16
Rodriguez Park	04/29/2013	SS	<0.10	<0.10	<0.50	<0.20	E0.39	E0.36
Rodriguez Park	04/29/2013	SSQ (replicate)	<0.10	<0.10	<0.50	<0.20	E0.53	E0.53
Rodriguez Park	05/14/2013	SB	0.01 bt	<0.10	<0.50	<0.20	E0.48	E0.36
Rodriguez Park	05/24/2013	SS	0.02 bt	<0.10	<0.50	<0.20	E0.59	E1.4
Rodriguez Park	06/24/2013	SB	<0.10	<0.10	<0.50	<0.20	E0.42	E0.25
Rodriguez Park	06/25/2014	SS	<110	<110	E0.18 t	<0.20	0.43	0.71

86 Occurrence and Concentrations of Selected Trace Elements and Halogenated Organic Compounds in Stream Sediments
Table 8. Concentrations of inorganic and organic constituents in streambed- and suspended-sediment samples collected from sites on Leon Creek, San Antonio, Texas, 2012–14.—Continued

[QC, quality control; NWQL, U.S. Geological Survey National Water Quality Laboratory; SB, bottom material; SBQ, QC sample - bottom material; SS, suspended sediment; SSQ, QC sample - suspended sediment; --, no data; <, less than; E, estimated; M, presence verified but not quantified; b, value extrapolated at low end; h, compound identified and verified after additional review; m, value is highly variable by this method; n, below the reporting level but at or above the detection level; t, below the detection level; v, analyte detected in laboratory blank]

Site identifier (table 1)	Date	Medium code (QC sample type)	Pentachloro-anisole (micrograms per kilogram)	Pentachloro-nitrobenzene (micrograms per kilogram)	Tefluthrin (micrograms per kilogram)	Tetradifon (micrograms per kilogram)	<i>trans</i> -Chlordane (micrograms per kilogram)	<i>trans</i> -Nonachlor (micrograms per kilogram)
Rodriguez Park	07/21/2014	SB	<0.10	<0.10	<0.50	<0.20	0.31	0.31
Morey Road	11/15/2012	SB	<0.10	<0.10	<0.50	<0.20	<0.20	<0.10
Morey Road	01/09/2013	SS	Insufficient sediment	Insufficient sediment	Insufficient sediment	Insufficient sediment	Insufficient sediment	Insufficient sediment
Morey Road	02/06/2013	SB	<0.10	<0.10	<0.50	<0.20	0.02 bt	0.02 bt
Morey Road	02/06/2013	SBQ (replicate)	<0.10	<0.10	<0.50	<0.20	E0.04 bt	E0.05 n
Morey Road	04/29/2013	SS	<0.10	<0.10	<0.50	<0.20	E1.2	E2.4
Morey Road	05/13/2013	SB	<0.10	<0.10	<0.50	<0.20	E0.03 bt	E0.06 n
Morey Road	05/24/2013	SS	0.03 bt	<0.10	<0.50	--	E0.46	E0.71
Morey Road	05/24/2013	SSQ (replicate)	<0.10	<0.10	<0.50	<0.20	0.47	E0.69
Morey Road	06/25/2013	SB	<0.10	<0.10	<0.50	--	0.18 n	E0.34
Morey Road	06/25/2013	SBQ (replicate)	<0.10	<0.10	<0.50	<0.20	0.05 t	E0.09 n
Morey Road	06/25/2014	SS	<160	<160	<0.50	<0.20	0.22	0.33
Morey Road	07/21/2014	SB	<0.10	<0.10	<0.50	<0.20	2.9	1.9
Joint Base	11/16/2012	SB	<0.10	<0.10	<0.50	<0.20	0.76	0.86
Joint Base	11/16/2012	SBQ (replicate)	<0.10	<0.10	<0.50	<0.20	0.38	0.41
Joint Base	02/06/2013	SB	<0.10	<0.10	<0.50	<0.20	0.32	0.34
Joint Base	05/13/2013	SB	<0.10	<0.10	<0.50	<0.20	E0.77	E1.3
Joint Base	06/24/2013	SB	<0.10	<0.10	<0.50	<0.20	1.9	E2.5
Joint Base	07/21/2014	SB	<0.10	<0.10	<0.50	<0.20	1.4	1.1
--	11/28/2012	SBQ (standard reference material)	0.12	<0.10	<0.50	2.9	<0.20	<0.10
--	04/09/2013	SBQ (standard reference material)	0.06 n	<0.10	<0.50	1.6	E0.05 t	<0.10

Table 8. Concentrations of inorganic and organic constituents in streambed- and suspended-sediment samples collected from sites on Leon Creek, San Antonio, Texas, 2012–14.—Continued

[QC, quality control; NWQL, U.S. Geological Survey National Water Quality Laboratory; SB, bottom material; SBQ, QC sample - bottom material; SS, suspended sediment; SSQ, QC sample - suspended sediment; --, no data; <, less than; E, estimated; M, presence verified but not quantified; b, value extrapolated at low end; h, compound identified and verified after additional review; m, value is highly variable by this method; n, below the reporting level but at or above the detection level; t, below the detection level; v, analyte detected in laboratory blank]

Site identifier (table 1)	Date	Medium code (QC sample type)	Trifluralin (micrograms per kilogram)	Total PCB (micrograms per kilogram) ¹	PCB congener 101 (micrograms per kilogram)	PCB congener 110 (micrograms per kilogram)	PCB congener 118 (micrograms per kilogram)	PCB congener 138 (micrograms per kilogram)
Loop 410	11/15/2012	SB	<0.20	<9.2	<1.0	<1.0	<0.10	<0.10
Loop 410	11/15/2012	SBQ (replicate)	<0.20	<9.2	<1.0	<1.0	<0.10	<0.10
Loop 410	01/09/2013	SS	<0.20	<9.2	<1.0	<1.0	<0.10	<0.10
Loop 410	02/07/2013	SB	<0.20	<9.2	<1.0	<1.0	<0.10	<0.10
Loop 410	02/07/2013	SBQ (replicate)	<0.20	<9.2	<1.0	<1.0	<0.10	<0.10
Loop 410	04/29/2013	SS	<0.20	<9.2	<1.0	<1.0	<0.10	<0.10
Loop 410	05/14/2013	SB	<0.20	<9.2	<1.0	<1.0	<0.10	<0.10
Loop 410	05/14/2013	SBQ (replicate)	<0.20	E0.4	<1.0	<1.0	<0.10	<0.10
Loop 410	05/24/2013	SS	<0.20	E0.9	<1.0	<1.0	<0.10	0.12
Loop 410	06/25/2013	SB	<0.20	E0.4	<1.0	<1.0	<0.10	<0.10
Loop 410	06/25/2014	SS	<0.20	E1.0	<1.0	<1.0	<0.11	0.09 n
Loop 410	07/22/2014	SB	<0.20	<9.2	<1.0	<1.0	<0.10	<0.10
Loop 410	07/22/2014	SBQ (replicate)	<0.20	<9.2	<1.0	<1.0	<0.10	<0.10
Rodriguez Park	11/15/2012	SB	<0.20	<9.2	<1.0	<1.0	<0.10	<0.10
Rodriguez Park	02/07/2013	SB	<0.20	E0.4	<1.0	<1.0	<0.10	<0.10
Rodriguez Park	04/29/2013	SS	<0.20	E1.0	<1.0	<1.0	<0.10	<0.10
Rodriguez Park	04/29/2013	SSQ (replicate)	<0.20	E0.9	<1.0	<1.0	<0.10	<0.10
Rodriguez Park	05/14/2013	SB	<0.20	E0.4	<1.0	<1.0	<0.10	0.05 t
Rodriguez Park	05/24/2013	SS	<0.20	E1.2	<1.0	<1.0	<0.10	0.14
Rodriguez Park	06/24/2013	SB	<0.20	E0.8	<1.0	<1.0	<0.10	<0.10
Rodriguez Park	06/25/2014	SS	<0.20	E2.2	<1.0	<1.0	0.38	<0.10

88 Occurrence and Concentrations of Selected Trace Elements and Halogenated Organic Compounds in Stream Sediments
Table 8. Concentrations of inorganic and organic constituents in streambed- and suspended-sediment samples collected from sites on Leon Creek, San Antonio, Texas, 2012–14.—Continued

[QC, quality control; NWQL, U.S. Geological Survey National Water Quality Laboratory; SB, bottom material; SBQ, QC sample - bottom material; SS, suspended sediment; SSQ, QC sample - suspended sediment; --, no data; <, less than; E, estimated; M, presence verified but not quantified; b, value extrapolated at low end; h, compound identified and verified after additional review; m, value is highly variable by this method; n, below the reporting level but at or above the detection level; t, below the detection level; v, analyte detected in laboratory blank]

Site identifier (table 1)	Date	Medium code (QC sample type)	Trifluralin (micrograms per kilogram)	Total PCB (micrograms per kilogram) ¹	PCB congener 101 (micrograms per kilogram)	PCB congener 110 (micrograms per kilogram)	PCB congener 118 (micrograms per kilogram)	PCB congener 138 (micrograms per kilogram)
Rodriguez Park	07/21/2014	SB	<0.20	E1.4	<1.0	<1.0	<0.10	<0.10
Morey Road	11/15/2012	SB	<0.20	<9.2	<1.0	<1.0	<0.10	<0.10
Morey Road	01/09/2013	SS	Insufficient sediment	Insufficient sediment	Insufficient sediment	Insufficient sediment	Insufficient sediment	Insufficient sediment
Morey Road	02/06/2013	SB	<0.20	<9.2	<1.0	<1.0	<0.10	<0.10
Morey Road	02/06/2013	SBQ (replicate)	<0.20	E0.2	<1.0	<1.0	<0.10	<0.10
Morey Road	04/29/2013	SS	<0.20	E1.7	<1.0	<1.0	<0.10	<0.10
Morey Road	05/13/2013	SB	<0.20	E0.2	<1.0	<1.0	<0.10	0.03 bt
Morey Road	05/24/2013	SS	<0.20	E1.2	<1.0	<1.0	<0.10	0.15
Morey Road	05/24/2013	SSQ (replicate)	<0.20	E1.9	E0.12 bt	E0.65 n	<0.10	E0.17
Morey Road	06/25/2013	SB	<0.20	E0.2	<1.0	<1.0	<0.10	E0.03 bt
Morey Road	06/25/2013	SBQ (replicate)	<0.20	E0.2	<1.0	<1.0	<0.10	<0.10
Morey Road	06/25/2014	SS	<0.20	E2.1	<1.0	<1.0	<0.10	<0.10
Morey Road	07/21/2014	SB	<0.20	<9.1	<1.0	<1.0	<0.10	<0.10
Joint Base	11/16/2012	SB	<0.20	E4.6	<1.0	<1.0	E0.18	<0.10
Joint Base	11/16/2012	SBQ (replicate)	<0.20	E3.8	<1.0	<1.0	<0.10	<0.10
Joint Base	02/06/2013	SB	<0.20	E2.2	<1.0	<1.0	<0.10	<0.10
Joint Base	05/13/2013	SB	<0.20	E7.5	<1.0	1.2	<0.10	1.2
Joint Base	06/24/2013	SB	<0.20	E8.7	<1.0	E2.7	E0.25	E0.58
Joint Base	07/21/2014	SB	<0.20	E7.0	<1.0	<5.3	0.31	<0.67
--	11/28/2012	SBQ (standard reference material)	<0.20	E14.5	<1.0	<1.0	1.5	1.7
--	04/09/2013	SBQ (standard reference material)	<0.20	E9.8	0.43 t	1.7	E0.73	1.3

Table 8. Concentrations of inorganic and organic constituents in streambed- and suspended-sediment samples collected from sites on Leon Creek, San Antonio, Texas, 2012–14.—Continued

[QC, quality control; NWQL, U.S. Geological Survey National Water Quality Laboratory; SB, bottom material; SBQ, QC sample - bottom material; SS, suspended sediment; SSQ, QC sample - suspended sediment; --, no data; <, less than; E, estimated; M, presence verified but not quantified; b, value extrapolated at low end; h, compound identified and verified after additional review; m, value is highly variable by this method; n, below the reporting level but at or above the detection level; t, below the detection level; v, analyte detected in laboratory blank]

Site identifier (table 1)	Date	Medium code (QC sample type)	PCB congener 146 (micrograms per kilogram)	PCB congener 149 (micrograms per kilogram)	PCB congener 151 (micrograms per kilogram)	PCB congener 170 (micrograms per kilogram)	PCB congener 174 (micrograms per kilogram)	PCB congener 177 (micrograms per kilogram)
Loop 410	11/15/2012	SB	<0.10	<1.0	<0.10	<0.10	<0.10	<0.10
Loop 410	11/15/2012	SBQ (replicate)	<0.10	<1.0	<0.10	<0.10	<0.10	<0.10
Loop 410	01/09/2013	SS	<0.10	<1.0	<0.10	<0.10	<0.10	<0.10
Loop 410	02/07/2013	SB	<0.10	<1.0	<0.10	<0.10	<0.10	<0.10
Loop 410	02/07/2013	SBQ (replicate)	<0.10	<1.0	<0.10	<0.10	<0.10	<0.10
Loop 410	04/29/2013	SS	<0.10	<1.0	<0.10	<0.10	<0.10	<0.10
Loop 410	05/14/2013	SB	<0.10	<1.0	<0.10	<0.10	<0.10	<0.10
Loop 410	05/14/2013	SBQ (replicate)	<0.10	<1.0	<0.10	0.03 bt	<0.10	<0.10
Loop 410	05/24/2013	SS	0.03 bt	<1.0	<0.10	0.06 t	0.07 n	0.06 t
Loop 410	06/25/2013	SB	<0.10	<1.0	<0.10	E0.03 bt	<0.10	<0.10
Loop 410	06/25/2014	SS	0.02 bt	<1.0	<0.10	0.10	<0.10	<0.10
Loop 410	07/22/2014	SB	<0.10	<1.0	<0.10	<0.10	<0.10	<0.10
Loop 410	07/22/2014	SBQ (replicate)	<0.10	<1.0	<0.10	<0.10	<0.10	<0.10
Rodriguez Park	11/15/2012	SB	<0.10	<1.0	<0.10	<0.10	<0.10	<0.10
Rodriguez Park	02/07/2013	SB	<0.10	<1.0	<0.10	0.02 bt	<0.10	<0.10
Rodriguez Park	04/29/2013	SS	<0.10	<1.0	<0.10	<0.10	<0.10	<0.10
Rodriguez Park	04/29/2013	SSQ (replicate)	<0.10	<1.0	<0.10	<0.10	<0.10	<0.10
Rodriguez Park	05/14/2013	SB	0.01 bt	<1.0	0.01 bt	0.03 bt	0.02 bt	0.02 bt
Rodriguez Park	05/24/2013	SS	0.03 bt	0.12 bt	0.05 t	0.07 n	0.08 n	0.06 n
Rodriguez Park	06/24/2013	SB	<0.10	<1.0	E0.04 bt	E0.06 t	E0.05 t	E0.05 t
Rodriguez Park	06/25/2014	SS	0.02 bt	<1.0	<0.10	0.21	0.14	<0.10

90 Occurrence and Concentrations of Selected Trace Elements and Halogenated Organic Compounds in Stream Sediments

Table 8. Concentrations of inorganic and organic constituents in streambed- and suspended-sediment samples collected from sites on Leon Creek, San Antonio, Texas, 2012–14.—Continued

[QC, quality control; NWQL, U.S. Geological Survey National Water Quality Laboratory; SB, bottom material; SBQ, QC sample - bottom material; SS, suspended sediment; SSQ, QC sample - suspended sediment; --, no data; <, less than; E, estimated; M, presence verified but not quantified; b, value extrapolated at low end; h, compound identified and verified after additional review; m, value is highly variable by this method; n, below the reporting level but at or above the detection level; t, below the detection level; v, analyte detected in laboratory blank]

Site identifier (table 1)	Date	Medium code (QC sample type)	PCB congener 146 (micrograms per kilogram)	PCB congener 149 (micrograms per kilogram)	PCB congener 151 (micrograms per kilogram)	PCB congener 170 (micrograms per kilogram)	PCB congener 174 (micrograms per kilogram)	PCB congener 177 (micrograms per kilogram)
Rodriguez Park	07/21/2014	SB	<0.10	<1.0	<0.10	0.09 n	0.06 n	<0.10
Morey Road	11/15/2012	SB	<0.10	<1.0	<0.10	<0.10	<0.10	<0.10
Morey Road	01/09/2013	SS	Insufficient sediment	Insufficient sediment	Insufficient sediment	Insufficient sediment	Insufficient sediment	Insufficient sediment
Morey Road	02/06/2013	SB	<0.10	<1.0	<0.10	<0.10	<0.10	<0.10
Morey Road	02/06/2013	SBQ (replicate)	<0.10	<1.0	<0.10	0.02 bt	<0.10	<0.10
Morey Road	04/29/2013	SS	<0.10	<1.0	<0.10	0.16	<0.10	<0.10
Morey Road	05/13/2013	SB	0.01 bt	<1.0	<0.10	0.01 bt	0.02 bt	0.01 bt
Morey Road	05/24/2013	SS	0.04 bt	0.13 bt	0.05 t	0.06 t	0.08 n	0.06 n
Morey Road	05/24/2013	SSQ (replicate)	0.03 bt	E0.14 bt	0.05 t	0.07 t	0.08 n	0.06 n
Morey Road	06/25/2013	SB	0.01 bt	<1.0	<0.10	0.01 bt	<0.10	0.01 bt
Morey Road	06/25/2013	SBQ (replicate)	0.01 bt	<1.0	<0.10	0.01 bt	0.02 bt	0.01 bt
Morey Road	06/25/2014	SS	<0.10	<1.0	<0.10	0.20	<0.10	<0.10
Morey Road	07/21/2014	SB	<0.10	<1.0	<0.10	<0.10	<0.10	<0.10
Joint Base	11/16/2012	SB	<0.12	<1.0	E0.14	E0.62	<0.10	<0.10
Joint Base	11/16/2012	SBQ (replicate)	<0.10	<1.0	<0.10	E0.30	<0.10	<0.10
Joint Base	02/06/2013	SB	0.12	<1.0	<0.10	0.23	0.13	0.05 t
Joint Base	05/13/2013	SB	E0.15	E0.55 n	0.11	0.49	E0.31	0.21
Joint Base	06/24/2013	SB	0.14	E0.54 n	E0.19	0.55	0.35	0.26
Joint Base	07/21/2014	SB	0.21	0.65 n	0.22	0.69	0.37	0.29
--	11/28/2012	SBQ (standard reference material)	0.58	0.52 n	0.36	0.87	0.57	0.49
--	04/09/2013	SBQ (standard reference material)	0.18	0.93 n	0.22	0.36	E0.25	0.20

Table 8. Concentrations of inorganic and organic constituents in streambed- and suspended-sediment samples collected from sites on Leon Creek, San Antonio, Texas, 2012–14.—Continued

[QC, quality control; NWQL, U.S. Geological Survey National Water Quality Laboratory; SB, bottom material; SBQ, QC sample - bottom material; SS, suspended sediment; SSQ, QC sample - suspended sediment; --, no data; <, less than; E, estimated; M, presence verified but not quantified; b, value extrapolated at low end; h, compound identified and verified after additional review; m, value is highly variable by this method; n, below the reporting level but at or above the detection level; t, below the detection level; v, analyte detected in laboratory blank]

Site identifier (table 1)	Date	Medium code (QC sample type)	PCB congener 180 (micrograms per kilogram)	PCB congener 183 (micrograms per kilogram)	PCB congener 187 (micrograms per kilogram)	PCB congener 194 (micrograms per kilogram)	PCB congener 206 (micrograms per kilogram)	PCB congener 49 (micrograms per kilogram)
Loop 410	11/15/2012	SB	<0.10	<0.10	<0.10	<0.10	<0.10	<2.0 m
Loop 410	11/15/2012	SBQ (replicate)	<0.10	<0.10	<0.10	<0.10	<0.10	<2.0 m
Loop 410	01/09/2013	SS	<0.10	<0.10	<0.10	<0.10	<0.10	<2.0 m
Loop 410	02/07/2013	SB	<0.10	<0.10	<0.10	<0.10	<0.10	<2.0 m
Loop 410	02/07/2013	SBQ (replicate)	<0.10	<0.10	<0.10	<0.10	<0.10	<2.0 m
Loop 410	04/29/2013	SS	<0.10	<0.10	<0.10	<0.10	<0.10	<2.0 m
Loop 410	05/14/2013	SB	<0.10	<0.10	<0.10	<0.10	<0.10	<2.0 m
Loop 410	05/14/2013	SBQ (replicate)	0.02 bt	<0.10	<0.10	<0.10	<0.10	<2.0 m
Loop 410	05/24/2013	SS	0.05 n	0.04 bt	0.05 t	0.03 bt	0.04 n	<2.0 m
Loop 410	06/25/2013	SB	E0.03 bt	<0.10	E0.03 bt	E0.03 bt	E0.01 bt	<2.0 m
Loop 410	06/25/2014	SS	<0.10	<0.10	0.06 n	<0.10	0.04 n	<2.0 m
Loop 410	07/22/2014	SB	<0.10	<0.10	<0.10	<0.10	<0.10	<2.0 m
Loop 410	07/22/2014	SBQ (replicate)	<0.10	<0.10	<0.10	<0.10	<0.10	<2.0 m
Rodriguez Park	11/15/2012	SB	<0.10	<0.10	<0.10	<0.10	<0.10	<2.0 m
Rodriguez Park	02/07/2013	SB	0.04 t	0.01 bt	0.02 bt	<0.10	0.04 bt	<2.0 m
Rodriguez Park	04/29/2013	SS	0.08 n	<0.10	<0.10	0.06 n	<0.10	<2.0 m
Rodriguez Park	04/29/2013	SSQ (replicate)	0.08 n	<0.10	<0.10	0.05 t	<0.10	<2.0 m
Rodriguez Park	05/14/2013	SB	0.04 bt	0.01 bt	0.03 bt	0.01 bt	0.01 bt	<2.0 m
Rodriguez Park	05/24/2013	SS	0.09 n	0.04 t	0.07 n	0.03 bt	0.04 n	<2.0 m
Rodriguez Park	06/24/2013	SB	E0.07 n	E0.04 t	E0.05 n	E0.04 t	E0.02 bt	<2.0 m
Rodriguez Park	06/25/2014	SS	E0.28 v	<0.10	0.16	<0.10	0.09 n	<2.0 m

92 Occurrence and Concentrations of Selected Trace Elements and Halogenated Organic Compounds in Stream Sediments

Table 8. Concentrations of inorganic and organic constituents in streambed- and suspended-sediment samples collected from sites on Leon Creek, San Antonio, Texas, 2012–14.—Continued

[QC, quality control; NWQL, U.S. Geological Survey National Water Quality Laboratory; SB, bottom material; SBQ, QC sample - bottom material; SS, suspended sediment; SSQ, QC sample - suspended sediment; --, no data; <, less than; E, estimated; M, presence verified but not quantified; b, value extrapolated at low end; h, compound identified and verified after additional review; m, value is highly variable by this method; n, below the reporting level but at or above the detection level; t, below the detection level; v, analyte detected in laboratory blank]

Site identifier (table 1)	Date	Medium code (QC sample type)	PCB congener 180 (micrograms per kilogram)	PCB congener 183 (micrograms per kilogram)	PCB congener 187 (micrograms per kilogram)	PCB congener 194 (micrograms per kilogram)	PCB congener 206 (micrograms per kilogram)	PCB congener 49 (micrograms per kilogram)
Rodriguez Park	07/21/2014	SB	0.12	<0.10	0.07 n	<0.10	<0.10	<2.0 m
Morey Road	11/15/2012	SB	<0.10	<0.10	<0.10	<0.10	<0.10	<2.0 m
Morey Road	01/09/2013	SS	Insufficient sediment	Insufficient sediment	Insufficient sediment	Insufficient sediment	Insufficient sediment	Insufficient sediment
Morey Road	02/06/2013	SB	0.01 bt	<0.10	<0.10	<0.10	<0.10	<2.0 m
Morey Road	02/06/2013	SBQ (replicate)	0.02 bt	<0.10	0.01 bt	0.01 bt	0.01 bt	<2.0 m
Morey Road	04/29/2013	SS	0.19	<0.10	0.07 n	0.11	0.08 n	<2.0 m
Morey Road	05/13/2013	SB	0.02 bt	0.01 bt	0.01 bt	0.01 bt	<0.10	<2.0 m
Morey Road	05/24/2013	SS	0.09 n	0.04 t	0.07 n	0.04 bt	0.04 n	<2.0 m
Morey Road	05/24/2013	SSQ (replicate)	0.08 n	0.05 t	0.06 n	0.03 bt	0.04 bt	<2.0 m
Morey Road	06/25/2013	SB	0.01 bt	0.01 bt	0.01 bt	0.01 bt	0.01 bt	<2.0 m
Morey Road	06/25/2013	SBQ (replicate)	0.02 bt	0.01 bt	0.01 bt	0.01 bt	0.01 bt	<2.0 m
Morey Road	06/25/2014	SS	E0.24 v	<0.10	0.14	<0.10	0.10 n	<2.0 m
Morey Road	07/21/2014	SB	0.04 t	<0.10	<0.10	<0.10	<0.10	<2.0 m
Joint Base	11/16/2012	SB	E0.96	E0.18	E0.41	<0.10	<0.10	<2.0 m
Joint Base	11/16/2012	SBQ (replicate)	E0.44	<0.10	E0.18	<0.10	<0.10	<2.0 m
Joint Base	02/06/2013	SB	0.45	0.09 n	0.18	0.05 t	0.09 n	<2.0 m
Joint Base	05/13/2013	SB	E0.85	E0.19	E0.37	E0.21	E0.14	<2.0 m
Joint Base	06/24/2013	SB	0.83	0.20	0.42	0.17	0.11	<2.0 m
Joint Base	07/21/2014	SB	1.1	0.21	0.51	0.22	0.18	<2.0 m
--	11/28/2012	SBQ (standard reference material)	1.5	0.56	0.81	0.52	1.2	<2.0 m
--	04/09/2013	SBQ (standard reference material)	E0.73	E0.17	E0.44	E0.23	E0.54	<2.0 m

Table 8. Concentrations of inorganic and organic constituents in streambed- and suspended-sediment samples collected from sites on Leon Creek, San Antonio, Texas, 2012–14.—Continued

[QC, quality control; NWQL, U.S. Geological Survey National Water Quality Laboratory; SB, bottom material; SBQ, QC sample - bottom material; SS, suspended sediment; SSQ, QC sample - suspended sediment; --, no data; <, less than; E, estimated; M, presence verified but not quantified; b, value extrapolated at low end; h, compound identified and verified after additional review; m, value is highly variable by this method; n, below the reporting level but at or above the detection level; t, below the detection level; v, analyte detected in laboratory blank]

Site identifier (table 1)	Date	Medium code (QC sample type)	PCB congener 52 (micrograms per kilogram)	PCB congener 70 (micrograms per kilogram)	1,2-Bis(2,4,6-tribromo-phenoxy) ethane (micrograms per kilogram)	PBDE congener 100 (micrograms per kilogram)	PBDE congener 138 (micrograms per kilogram)	PBDE congener 153 (micrograms per kilogram)
Loop 410	11/15/2012	SB	<1.0 m	<2.0	<0.10	<0.11	<0.10	<0.10
Loop 410	11/15/2012	SBQ (replicate)	<1.0 m	<2.0	<0.10	<0.10	<0.10	<0.10
Loop 410	01/09/2013	SS	<1.0 m	<2.0	E0.92	E6.2 v	0.63	2.9
Loop 410	02/07/2013	SB	<1.0 m	<2.0	<0.10	<0.11	<0.10	0.05 n
Loop 410	02/07/2013	SBQ (replicate)	<1.0 m	<2.0	E0.15	E0.08 n	<0.10	E0.08 n
Loop 410	04/29/2013	SS	<1.0 m	<2.0	E1.8	E1.8	E0.23	E1.3
Loop 410	05/14/2013	SB	<1.0 m	<2.0	E0.22	E0.09 n	<0.10	E0.06 n
Loop 410	05/14/2013	SBQ (replicate)	<1.0 m	<2.0	E0.09 n	<0.16	<0.10	E0.07 n
Loop 410	05/24/2013	SS	<1.0 m	<2.0	E0.42	E1.1v	<0.27	E0.97
Loop 410	06/25/2013	SB	<1.0 m	<2.0	<0.10	<0.14	<0.10	E0.04 bt
Loop 410	06/25/2014	SS	<1.0 m	<2.0	E0.13	E0.60 v	E0.10 n	0.57
Loop 410	07/22/2014	SB	<1.0 m	<2.0	<0.10	0.13	<0.10	<0.10
Loop 410	07/22/2014	SBQ (replicate)	<1.0 m	<2.0	<0.10	<0.12	<0.10	<0.10
Rodriguez Park	11/15/2012	SB	<1.0 m	<2.0	<0.10	<0.14	<0.10	<0.10
Rodriguez Park	02/07/2013	SB	<1.0 m	<2.0	E0.06 n	<0.10	<0.10	0.02 bt
Rodriguez Park	04/29/2013	SS	<1.0 m	<2.0	E0.74	E0.49	<0.10	E0.56
Rodriguez Park	04/29/2013	SSQ (replicate)	<1.0 m	<2.0	E0.43	E0.43	<0.10	E0.51
Rodriguez Park	05/14/2013	SB	<1.0 m	<2.0	E0.04 bt	<0.11	<0.10	E0.07 n
Rodriguez Park	05/24/2013	SS	<1.0 m	<2.0	E0.54	E0.58 v	E0.15	E0.48
Rodriguez Park	06/24/2013	SB	<1.0 m	<2.0	E0.05 n	<0.19	E0.02 bt	E0.07 n
Rodriguez Park	06/25/2014	SS	<1.0 m	<2.0	<0.34	E1.4 v	<0.10	0.85

94 Occurrence and Concentrations of Selected Trace Elements and Halogenated Organic Compounds in Stream Sediments

Table 8. Concentrations of inorganic and organic constituents in streambed- and suspended-sediment samples collected from sites on Leon Creek, San Antonio, Texas, 2012–14.—Continued

[QC, quality control; NWQL, U.S. Geological Survey National Water Quality Laboratory; SB, bottom material; SBQ, QC sample - bottom material; SS, suspended sediment; SSQ, QC sample - suspended sediment; --, no data; <, less than; E, estimated; M, presence verified but not quantified; b, value extrapolated at low end; h, compound identified and verified after additional review; m, value is highly variable by this method; n, below the reporting level but at or above the detection level; t, below the detection level; v, analyte detected in laboratory blank]

Site identifier (table 1)	Date	Medium code (QC sample type)	PCB congener 52 (micrograms per kilogram)	PCB congener 70 (micrograms per kilogram)	1,2-Bis(2,4,6-tribromophenoxy) ethane (micrograms per kilogram)	PBDE congener 100 (micrograms per kilogram)	PBDE congener 138 (micrograms per kilogram)	PBDE congener 153 (micrograms per kilogram)
Rodriguez Park	07/21/2014	SB	<1.0 m	<2.0	<0.10	<0.10	<0.10	<0.10
Morey Road	11/15/2012	SB	<1.0 m	<2.0	<0.10	<0.10	<0.10	<0.10
Morey Road	01/09/2013	SS	Insufficient sediment	Insufficient sediment	Insufficient sediment	Insufficient sediment	Insufficient sediment	Insufficient sediment
Morey Road	02/06/2013	SB	<1.0 m	<2.0	<0.10	<0.10	<0.10	<0.10
Morey Road	02/06/2013	SBQ (replicate)	<1.0 m	<2.0	E0.05 n	E0.08 n	<0.10	E0.05 n
Morey Road	04/29/2013	SS	<1.0 m	<2.0	E0.61	E0.51	<0.10	E0.48
Morey Road	05/13/2013	SB	<1.0 m	<2.0	<0.10	<0.10	<0.10	E0.02 bt
Morey Road	05/24/2013	SS	<1.0 m	<2.0	E2.1	E0.37 v	<0.10	E0.25
Morey Road	05/24/2013	SSQ (replicate)	<1.0 m	<2.0	<0.20	E0.52 v	<0.10	E0.38
Morey Road	06/25/2013	SB	<1.0 m	<2.0	<0.10	<0.10	<0.10	E0.03 bt
Morey Road	06/25/2013	SBQ (replicate)	<1.0 m	<2.0	<0.10	<0.10	<0.10	E0.03 bt
Morey Road	06/25/2014	SS	<1.0 m	<2.0	E0.24	E0.56 v	<0.10	0.41
Morey Road	07/21/2014	SB	<1.0 m	<2.0	<0.10	0.06 n	<0.10	<0.10
Joint Base	11/16/2012	SB	<1.0 m	<2.0	<0.10	<0.20	<0.10	<0.10
Joint Base	11/16/2012	SBQ (replicate)	<1.0 m	<2.0	<0.10	<0.13	<0.10	<0.10
Joint Base	02/06/2013	SB	<1.0 m	<2.0	<0.10	<0.18	<0.10	0.08 n
Joint Base	05/13/2013	SB	<1.0 m	<2.0	E0.31	E0.28	<0.10	E0.17
Joint Base	06/24/2013	SB	<1.0 m	<2.0	E0.26	E0.33 v	<0.10	E0.19
Joint Base	07/21/2014	SB	<1.0 m	<2.0	<0.14	0.16	<0.10	<0.10
--	11/28/2012	SBQ (standard reference material)	<1.0 m	<2.0	<0.10	<0.41	<0.10	<0.10
--	04/09/2013	SBQ (standard reference material)	<1.0 m	<2.0	E0.17	E0.18	<0.10	E0.08 n

Table 8. Concentrations of inorganic and organic constituents in streambed- and suspended-sediment samples collected from sites on Leon Creek, San Antonio, Texas, 2012–14.—Continued

[QC, quality control; NWQL, U.S. Geological Survey National Water Quality Laboratory; SB, bottom material; SBQ, QC sample - bottom material; SS, suspended sediment; SSQ, QC sample - suspended sediment; --, no data; <, less than; E, estimated; M, presence verified but not quantified; b, value extrapolated at low end; h, compound identified and verified after additional review; m, value is highly variable by this method; n, below the reporting level but at or above the detection level; t, below the detection level; v, analyte detected in laboratory blank]

Site identifier (table 1)	Date	Medium code (QC sample type)	PBDE congener 154 (micrograms per kilogram)	PBDE congener 183 (micrograms per kilogram)	PBDE congener 47 (micrograms per kilogram)	PBDE congener 66 (micrograms per kilogram)	PBDE congener 71 (micrograms per kilogram)	PBDE congener 85 (micrograms per kilogram)
Loop 410	11/15/2012	SB	<0.10	<0.10	<0.90	<0.10	<0.10	<0.10
Loop 410	11/15/2012	SBQ (replicate)	<0.10	<0.10	<0.88	<0.10	<0.10	<0.10
Loop 410	01/09/2013	SS	3.1	5.2	E19.8 v	0.82	<0.10	1.5
Loop 410	02/07/2013	SB	0.02 bt	<0.10	<0.72	<0.10	<0.10	<0.10
Loop 410	02/07/2013	SBQ (replicate)	E0.04 t	<0.10	E0.57 v	<0.10	<0.10	E0.01 btm
Loop 410	04/29/2013	SS	E0.89	<0.10	E6.8 v	E0.34	<0.10	E0.62
Loop 410	05/14/2013	SB	E0.03 bt	<0.10	E0.64 v	<0.10	<0.10	E0.01 btm
Loop 410	05/14/2013	SBQ (replicate)	E0.04 t	<0.50	<0.76	<0.10	<0.10	<0.10
Loop 410	05/24/2013	SS	E0.70	E0.47	<3.3	E0.07 n	<0.10	E0.46
Loop 410	06/25/2013	SB	E0.03 bt	<0.10	<1.1	<0.10	<0.10	<0.10
Loop 410	06/25/2014	SS	0.41	E0.20	E1.9 v	0.10	<0.10	E0.19
Loop 410	07/22/2014	SB	<0.10	<0.10	<0.50	<0.10	<0.10	<0.10
Loop 410	07/22/2014	SBQ (replicate)	<0.10	<0.10	<0.44	<0.10	<0.10	<0.10
Rodriguez Park	11/15/2012	SB	<0.10	<0.10	<1.5	<0.10	<0.10	<0.10
Rodriguez Park	02/07/2013	SB	0.02 bt	<0.10	<0.28	<0.10	<0.10	<0.10
Rodriguez Park	04/29/2013	SS	E0.35	<0.10	E2.4 v	E0.03 bt	<0.10	E0.20
Rodriguez Park	04/29/2013	SSQ (replicate)	E0.30	<0.10	E2.0	E0.02 bt	<0.10	E0.15
Rodriguez Park	05/14/2013	SB	E0.06 n	<0.50	<0.47	<0.10	<0.10	E0.04 btm
Rodriguez Park	05/24/2013	SS	E0.32	<0.10	<2.2	0.04 t	<0.10	E0.24
Rodriguez Park	06/24/2013	SB	E0.06 n	<0.10	<1.5	E0.02 bt	<0.10	<0.10
Rodriguez Park	06/25/2014	SS	0.73	<0.10	E5.8 v	<0.10	<0.10	E0.43

96 Occurrence and Concentrations of Selected Trace Elements and Halogenated Organic Compounds in Stream Sediments

Table 8. Concentrations of inorganic and organic constituents in streambed- and suspended-sediment samples collected from sites on Leon Creek, San Antonio, Texas, 2012–14.—Continued

[QC, quality control; NWQL, U.S. Geological Survey National Water Quality Laboratory; SB, bottom material; SBQ, QC sample - bottom material; SS, suspended sediment; SSQ, QC sample - suspended sediment; --, no data; <, less than; E, estimated; M, presence verified but not quantified; b, value extrapolated at low end; h, compound identified and verified after additional review; m, value is highly variable by this method; n, below the reporting level but at or above the detection level; t, below the detection level; v, analyte detected in laboratory blank]

Site identifier (table 1)	Date	Medium code (QC sample type)	PBDE congener 154 (micrograms per kilogram)	PBDE congener 183 (micrograms per kilogram)	PBDE congener 47 (micrograms per kilogram)	PBDE congener 66 (micrograms per kilogram)	PBDE congener 71 (micrograms per kilogram)	PBDE congener 85 (micrograms per kilogram)
Rodriguez Park	07/21/2014	SB	<0.10	<0.10	E0.48 v	<0.10	<0.10	<0.10
Morey Road	11/15/2012	SB	<0.10	<0.10	<1.5	<0.10	<0.10	<0.10
Morey Road	01/09/2013	SS	Insufficient sediment	Insufficient sediment	Insufficient sediment	Insufficient sediment	Insufficient sediment	Insufficient sediment
Morey Road	02/06/2013	SB	<0.10	<0.10	<0.21	<0.10	<0.10	<0.10
Morey Road	02/06/2013	SBQ (replicate)	E0.03 bt	<0.10	<0.37	E0.01 bt	<0.10	<0.10
Morey Road	04/29/2013	SS	E0.33	<0.10	E2.9 v	E0.03 bt	<0.10	E0.19
Morey Road	05/13/2013	SB	<0.10	<0.50	<0.27	<0.10	<0.10	E0.02 btm
Morey Road	05/24/2013	SS	E0.18	<0.50	<1.4	E0.01 bt	<0.10	<0.12
Morey Road	05/24/2013	SSQ (replicate)	E0.27	<0.50	<1.6	0.02 bt	<0.10	<0.22
Morey Road	06/25/2013	SB	<0.10	<0.50	<0.23	<0.10	<0.10	<0.10
Morey Road	06/25/2013	SBQ (replicate)	E0.25	<0.50	<0.20	<0.10	<0.10	<0.10
Morey Road	06/25/2014	SS	<16.4	E0.26	E2.1 v	<0.10	<0.10	E0.22
Morey Road	07/21/2014	SB	<0.27	<0.10	<0.40	<0.10	<0.10	<0.10
Joint Base	11/16/2012	SB	<0.10	<0.10	<1.5	<0.10	<0.10	<0.10
Joint Base	11/16/2012	SBQ (replicate)	<0.10	<0.10	<1.0	<0.10	<0.10	<0.10
Joint Base	02/06/2013	SB	0.03 bt	<0.10	<1.3	<0.10	<0.10	0.04 t
Joint Base	05/13/2013	SB	E0.11	<0.10	E1.6 v	E0.01 bt	<0.10	E0.07 nm
Joint Base	06/24/2013	SB	E0.17	<0.50	<1.1	E0.01 bt	<0.10	<0.10
Joint Base	07/21/2014	SB	0.37	<0.10	E0.77 v	0.03 bt	<0.10	<0.10
--	11/28/2012	SBQ (standard reference material)	<0.10	<0.10	4.0	<0.10	<0.10	<0.10
--	04/09/2013	SBQ (standard reference material)	E0.04 t	<0.10	E1.7 v	E0.03 bt	<0.10	E0.15

Table 8. Concentrations of inorganic and organic constituents in streambed- and suspended-sediment samples collected from sites on Leon Creek, San Antonio, Texas, 2012–14.—Continued

[QC, quality control; NWQL, U.S. Geological Survey National Water Quality Laboratory; SB, bottom material; SBQ, QC sample - bottom material; SS, suspended sediment; SSQ, QC sample - suspended sediment; --, no data; <, less than; E, estimated; M, presence verified but not quantified; b, value extrapolated at low end; h, compound identified and verified after additional review; m, value is highly variable by this method; n, below the reporting level but at or above the detection level; t, below the detection level; v, analyte detected in laboratory blank]

Site identifier (table 1)	Date	Medium code (QC sample type)	PBDE congener 99 (micrograms per kilogram)	Dechlorane plus (micrograms per kilogram)	Methyl triclosan (micrograms per kilogram)	Octachloro-styrene (micrograms per kilogram)	Pentabromo-toluene (micrograms per kilogram)	Triclosan (micrograms per kilogram)
Loop 410	11/15/2012	SB	<0.35	<1.0	<6.0	<1.0	<1.0	--
Loop 410	11/15/2012	SBQ (replicate)	<0.27	<1.0	<6.0	<1.0	<1.0	--
Loop 410	01/09/2013	SS	E23.8 v	1.3	<6.0	<1.0	<1.0	--
Loop 410	02/07/2013	SB	<0.43	<1.0	<6.0	<1.0	<1.0	--
Loop 410	02/07/2013	SBQ (replicate)	E0.53 v	<1.0	<6.0	<1.0	<1.0	--
Loop 410	04/29/2013	SS	E9.6 v	E1.0 n	<6.0	<1.0	<1.0	--
Loop 410	05/14/2013	SB	E0.46 v	E0.43 n	<6.0	<1.0	<1.0	--
Loop 410	05/14/2013	SBQ (replicate)	<0.63	E0.14 t	<6.0	<1.0	<1.0	<4.0 m
Loop 410	05/24/2013	SS	E4.0 v	E0.16 t	<6.0	<1.0	<1.0	<4.0 m
Loop 410	06/25/2013	SB	<0.51	E0.07 t	<6.0	<1.0	<1.0	E0.38 bmt
Loop 410	06/25/2014	SS	E2.9 v	0.32 n	<6.0	<1.0	0.04 bt	E1.7 mt
Loop 410	07/22/2014	SB	E0.43 v	<1.0	<6.0	<1.0	<1.0	<4.0 m
Loop 410	07/22/2014	SBQ (replicate)	0.38 v	<1.0	<6.0	<1.0	<1.0	<4.0 m
Rodriguez Park	11/15/2012	SB	<0.48	<1.0	<6.0	<1.0	<1.0	--
Rodriguez Park	02/07/2013	SB	<0.20	0.05 t	<6.0	<1.0	<1.0	--
Rodriguez Park	04/29/2013	SS	E2.6 v	E0.34 n	<6.0	<1.0	<1.0	--
Rodriguez Park	04/29/2013	SSQ (replicate)	E2.2	E0.42 n	<6.0	<1.0	<1.0	--
Rodriguez Park	05/14/2013	SB	<0.41	E0.14 t	<6.0	<1.0	<1.0	<4.0 m
Rodriguez Park	05/24/2013	SS	E2.6 v	0.27 t	<6.0	<1.0	<1.0	<4.0 m
Rodriguez Park	06/24/2013	SB	<0.90	<1.0	E0.36 bt	<1.0	<1.0	E1.7 mt
Rodriguez Park	06/25/2014	SS	E7.1 v	1.4	<6.0	<1.0	<1.0	E15.6 m

Table 8. Concentrations of inorganic and organic constituents in streambed- and suspended-sediment samples collected from sites on Leon Creek, San Antonio, Texas, 2012–14.—Continued

[QC, quality control; NWQL, U.S. Geological Survey National Water Quality Laboratory; SB, bottom material; SBQ, QC sample - bottom material; SS, suspended sediment; SSQ, QC sample - suspended sediment; --, no data; <, less than; E, estimated; M, presence verified but not quantified; b, value extrapolated at low end; h, compound identified and verified after additional review; m, value is highly variable by this method; n, below the reporting level but at or above the detection level; t, below the detection level; v, analyte detected in laboratory blank]

Site identifier (table 1)	Date	Medium code (QC sample type)	PBDE congener 99 (micrograms per kilogram)	Dechlorane plus (micrograms per kilogram)	Methyl triclosan (micrograms per kilogram)	Octachloro-styrene (micrograms per kilogram)	Pentabromo-toluene (micrograms per kilogram)	Triclosan (micrograms per kilogram)
Rodriguez Park	07/21/2014	SB	E0.29 v	<1.0	<6.0	<1.0	<1.0	<4.0 m
Morey Road	11/15/2012	SB	<0.30	<1.0	<6.0	<1.0	<1.0	--
Morey Road	01/09/2013	SS	Insufficient sediment	Insufficient sediment	Insufficient sediment	Insufficient sediment	Insufficient sediment	Insufficient sediment
Morey Road	02/06/2013	SB	<0.20	0.10 t	<6.0	<1.0	<1.0	--
Morey Road	02/06/2013	SBQ (replicate)	E0.29 v	E0.59 n	<6.0	<1.0	<1.0	--
Morey Road	04/29/2013	SS	E2.9 v	E2.6	<6.0	<1.0	<1.0	E5.0 m
Morey Road	05/13/2013	SB	<0.20	E0.14 t	<6.0	<1.0	<1.0	<4.0 m
Morey Road	05/24/2013	SS	E1.5 v	E0.20 t	<6.0	<1.0	<1.0	<4.0 m
Morey Road	05/24/2013	SSQ (replicate)	1.8 v	<1.0	<6.0	<1.0	<1.0	<4.0 m
Morey Road	06/25/2013	SB	<0.20	E0.31 n	<6.0	<1.0	<1.0	<4.0 m
Morey Road	06/25/2013	SBQ (replicate)	<0.20	E0.29 t	<6.0	<1.0	<1.0	<4.0 m
Morey Road	06/25/2014	SS	E2.7 v	0.46 n	<6.0	<1.0	<1.0	E14.3 m
Morey Road	07/21/2014	SB	E0.16 v	<1.0	<6.0	<1.0	<1.0	<4.0 m
Joint Base	11/16/2012	SB	<0.66	0.71 n	<6.0	<1.0	<1.0	--
Joint Base	11/16/2012	SBQ (replicate)	<0.47	<1.0	<6.0	<1.0	<1.0	--
Joint Base	02/06/2013	SB	<0.76	0.42 n	<6.0	<1.0	<1.0	--
Joint Base	05/13/2013	SB	E1.2 v	E0.75 n	<6.0	<1.0	<1.0	--
Joint Base	06/24/2013	SB	E1.2 v	E0.96 n	<6.0	<1.0	<1.0	<4.0 m
Joint Base	07/21/2014	SB	E0.55 v	0.54 n	<6.0	<1.0	<1.0	<4.0 m
--	11/28/2012	SBQ (standard reference material)	E1.0	<1.0	<6.0	<1.0	<1.0	--
--	04/09/2013	SBQ (standard reference material)	E0.73	E0.83 n	<6.0	<1.0	<1.0	--

Table 8. Concentrations of inorganic and organic constituents in streambed- and suspended-sediment samples collected from sites on Leon Creek, San Antonio, Texas, 2012–14.—Continued

[QC, quality control; NWQL, U.S. Geological Survey National Water Quality Laboratory; SB, bottom material; SBQ, QC sample - bottom material; SS, suspended sediment; SSQ, QC sample - suspended sediment; --, no data; <, less than; E, estimated; M, presence verified but not quantified; b, value extrapolated at low end; h, compound identified and verified after additional review; m, value is highly variable by this method; n, below the reporting level but at or above the detection level; t, below the detection level; v, analyte detected in laboratory blank]

Site identifier (table 1)	Date	Medium code (QC sample type)	Organic carbon, bed sediment, dry weight (percent)	Thorium (milligrams per kilogram)	Uranium (milligrams per kilogram)
Loop 410	11/15/2012	SB	0.60	6.0	2.2
Loop 410	11/15/2012	SBQ (replicate)	0.23	6.0	2.3
Loop 410	01/09/2013	SS	Insufficient sediment	Insufficient sediment	Insufficient sediment
Loop 410	02/07/2013	SB	0.86	5.0	2.0
Loop 410	02/07/2013	SBQ (replicate)	0.65	5.0	2.0
Loop 410	04/29/2013	SS	4.1	5.6	1.7
Loop 410	05/14/2013	SB	0.85	6.0	2.1
Loop 410	05/14/2013	SBQ (replicate)	0.85	5.0	2.0
Loop 410	05/24/2013	SS	1.7	5.9	2.0
Loop 410	06/25/2013	SB	0.59	7.0	2.1
Loop 410	06/25/2014	SS	Insufficient sediment	7.2	1.9
Loop 410	07/22/2014	SB	0.77	5.0	2.2
Loop 410	07/22/2014	SBQ (replicate)	0.81	5.0	2.3
Rodriguez Park	11/15/2012	SB	1.5	8.0	2.1
Rodriguez Park	02/07/2013	SB	1.5	7.0	1.8
Rodriguez Park	04/29/2013	SS	3.0	7.4	1.7
Rodriguez Park	04/29/2013	SSQ (replicate)	3.1	7.3	1.7
Rodriguez Park	05/14/2013	SB	0.83	7.0	2.0
Rodriguez Park	05/24/2013	SS	1.9	7.2	1.9
Rodriguez Park	06/24/2013	SB	1.7	7.0	1.9
Rodriguez Park	06/25/2014	SS	Insufficient sediment	7.9	2.0
Rodriguez Park	07/21/2014	SB	2.0	7.0	1.9
Morey Road	11/15/2012	SB	1.6	7.0	2.0
Morey Road	01/09/2013	SS	Insufficient sediment	Insufficient sediment	Insufficient sediment
Morey Road	02/06/2013	SB	1.6	7.0	1.8
Morey Road	02/06/2013	SBQ (replicate)	1.6	6.0	1.9
Morey Road	04/29/2013	SS	4.6	Insufficient sediment	Insufficient sediment
Morey Road	05/13/2013	SB	1.1	7.0	1.9
Morey Road	05/24/2013	SS	1.4	6.7	1.9
Morey Road	05/24/2013	SSQ (replicate)	1.7	6.9	1.9
Morey Road	06/25/2013	SB	1.4	7.0	1.7
Morey Road	06/25/2013	SBQ (replicate)	1.5	6.0	1.6
Morey Road	06/25/2014	SS	Insufficient sediment	8.4	2.0
Morey Road	07/21/2014	SB	1.7	7.0	1.8
Joint Base	11/16/2012	SB	1.9	8.0	1.9
Joint Base	11/16/2012	SBQ (replicate)	1.6	8.0	1.9
Joint Base	02/06/2013	SB	1.8	6.0	1.6
Joint Base	05/13/2013	SB	1.1	7.0	1.7
Joint Base	06/24/2013	SB	1.4	8.0	1.9
Joint Base	07/21/2014	SB	2.0	7.0	1.6
--	11/28/2012	SBQ (standard reference material)	2.6	9.0	3.0
--	04/09/2013	SBQ (standard reference material)	2.3	8.0	2.7

¹Total PCB was computed as the sum of the 18 reported congeners using the Kaplan-Meier method for summing nondetects (Helsel, 2009).

Publishing support provided by
Lafayette Publishing Service Center

Information regarding water resources in Texas is available at
<http://tx.usgs.gov/>

